

2023 catalog

For CO₂ and fiber laser consumables
Replacement parts suitable for Trumpf[®]



Centricut delivers

- OEM quality nozzles, ceramics and optics
- Technical and application support from our OEM-trained technicians
- 100% satisfaction guarantee

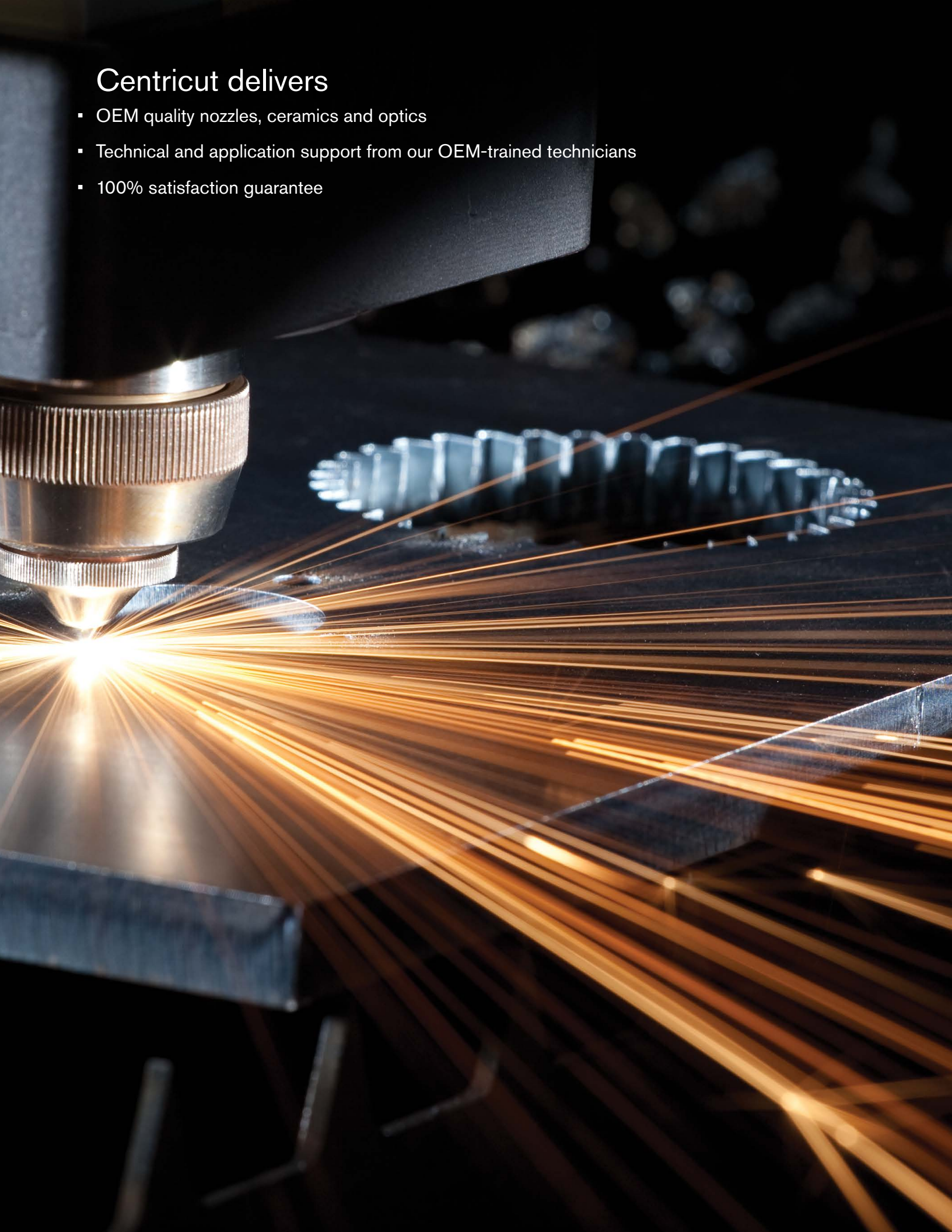

CO₂ and fiber laser nozzles

Nozzle options

All Centricut nozzles are engineered and manufactured to the highest standards. Select the OEM quality nozzle best suited for your application needs

Copper

Most commonly used nozzle offering good durability and nozzle life. Primary nozzle type for fiber lasers.

Chrome plated

Shiny, mirror-like finish provides increased spatter resistance, improved durability and longer life than copper nozzles. Not recommended for use on fiber lasers.

Look for CP in the part number to identify a chrome plated nozzle

Hard chrome plated

Premium nozzles offering the highest level of durability and longest nozzle life. These nozzles are not as shiny as chrome plated and have a dull appearance. Not recommended for use on fiber lasers.

Look for HCP in the part number to identify a hard chrome nozzle.

CP (chrome plated)	Nozzles plated with chrome for increased durability. These nozzles are easier to clean, resist damage due to 'tip-ups' and have better spatter resistance over non-plated nozzles. For use in all laser cutting applications.
Conical	Conical internal geometry for high pressure, non-ferrous cutting applications using nitrogen, air or argon.
Cylindrical	Cylindrical internal geometry for low pressure, mild steel cutting applications using oxygen.
Double	Insert pressed into a standard cylindrical nozzle for improved edge quality, laminar gas flow and spatter resistance. Primarily used in mild steel applications.
HCP (hard chrome plated)	Enhanced durability chrome plated nozzles. These nozzles are easier to clean, resist damage due to 'tip-ups' and have better spatter resistance over non-plated nozzles. For use in all laser cutting applications.
HP (high pressure) HD (high density)	Conical style nozzle for high pressure, non-ferrous cutting applications using nitrogen, air or argon.
Inner	Also referred to as a 'nozzle insert'. Works in conjunction with an outer nozzle to create a double nozzle. Primarily used in mild steel applications.
Low pressure	Cylindrical style nozzle for low pressure, mild steel cutting applications using oxygen.
Outer	Works in conjunction with an inner nozzle to create a double nozzle. Primarily used in mild steel applications.
Shower	Nozzles with a center orifice surrounded by smaller jets. The smaller jets focus the assist gas into the kerf, creating improved edge quality and the ability to cut thicker material. Primarily used in mild steel applications.

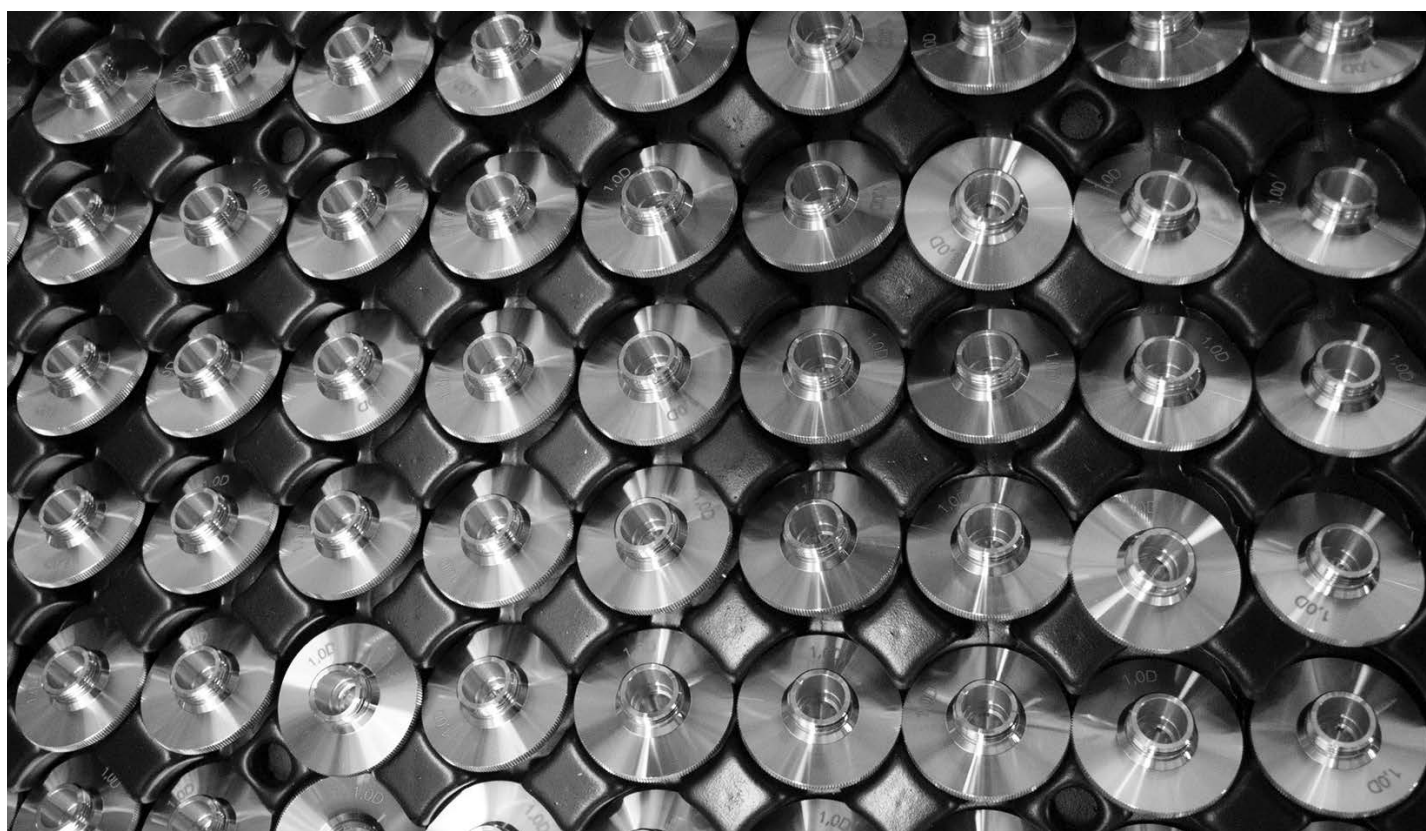

CO₂ and fiber laser optics

Optics key

Lens	
MEN	Meniscus
PLX	Plano-convex
MTD	Mounted
Not MTD	Not mounted
PO	Plano
MP5 or ULA	Ultra low absorption
AR	Anti-reflection
ZNSE	Zinc selenide
FS	Fused silica
DIA	Diameter
FL	Focal length
ET	Edge thickness
WD	Working distance

How to handle optics

Follow these easy steps, when cleaning or changing your optic, to help maximize the life and performance of your lens

- Avoid touching coated surfaces of the lens and hold the optic by its sides
- Wear powder-free finger cots or latex gloves when handling
- Do not use any tools or sharp objects when handling the optic or when removing it from its packaging
- Ensure the work surface is clean and free of oils, grease and dirt
- Do not place the optic on hard surfaces as they scratch easily
- Once the optic has been unpacked, carefully place it on the lens tissue in which it was originally wrapped

Optics disposal

It is important to dispose of used laser optics at a licensed industrial waste facility which is in compliance with all local, state, and federal regulations. If you don't have access to a licensed industrial waste facility, and purchased your laser optics through Centricut, you may return them to Centricut for proper disposal. This service is only available to Centricut customers.

All optics returned to Centricut must:

- Include return authorization and invoice numbers
- Be sealed in a plastic bag to minimize any hazards
- Remove excess ZnSe powder prior to sealing

*Acceptance of goods will be refused if not packaged correctly or if the return authorization number isn't included



Optics

Centricut part number	Reference number	Type	Material	Diameter	Focal length	Edge thickness
Fiber laser lens						
NT375-7955		PLX	FS	30 mm	123 mm	3.82 mm
TR300-9799	1869799	PLX	FS	30 mm	146 mm	8.0 mm
TR300-3107	1603107	PLX	FS	40 mm	150 mm	8.0 mm
AM313-0238	7710238, 71565737	PLX	FS	50.8 mm	190 mm	11.4 mm
SA384-0022	316-301-0022, 970128	PLX	FS	25.4 mm	200 mm	6.35 mm
SA384-0026	316-301-0026, ESTFL02119	PLX	FS	38.1 mm	210 mm	6.35 mm
PR361-8988NM	968988, 344631	PLX	FS	1.5"	5.0"	.280"
MB312-8858		PLX	FS	2.0"	7.5"	.45"
PR361-0773	970773/M15-15-B X-SP-7MM	PLX MTD	FS	1.5"	5.0"	.275"
PR361-8988	LH968988PVL, 576.41.005	PLX MTD	FS	1.5"	5.0"	.280"

Centricut part number	Reference number	Material	Diameter	Edge thickness
Fiber laser windows				
PT317-1424	P0588-1022-00001	FS	21.5 mm	2.0 mm
PT317-0589	970397, 6930003260, P0589-360-00002, R26RT006410, R26ZC90110	FS	22.35 mm	4.0 mm
PT317-9360	6930003260, P0589-360-00001	FS	22.35 mm	4.0 mm
MB312-2336	632336-117	FS	25.4 mm	4.0 mm
RT300-0035 NEW	211LCG0035, 211LCG0037	FS	27.9 mm	4.1 mm
PT317-0010	P0253-1034-00001	FS	30.0 mm	1.5 mm
TR300-6719	766719, P0795-1201-00002	FS	30.0 mm	5.0 mm
SA384-0007	316-304-0007, ESTFL001407, 632755-117	FS	32.0 mm	6.35 mm
BY314-5979 NEW	10086368, 10071591, 5335979	Sapphire	34.0 mm	2.8 mm
TR300-4767	1614767	FS	34.0 mm	4.9 mm
PR361-0089	1057.81000.089	FS	35.0 mm	1.5 mm
BY314-5746	968752, 10045746, 10-02-01-5511	QTZ	36.0 mm	5.0 mm
PR361-0474	970474	FS	37.0 mm	4.0 mm
PT317-1551	P0595-61551, P0595-58601-61551	FS	37.0 mm	7.0 mm
PT317-1425	SCR-01	FS	38.0 mm	5.2 mm
CN307-3987	913987, 71598028	FS	38.1 mm	1.6 mm
MZ315-6850 NEW	Z50ZZ016850	FS	42.0 mm	9.0 mm
MZ315-5350	Z50SA015350, W495	FS	42.0 mm	9.0 mm
AM313-1308	71571308, 5172635	FS	45.0 mm	3.0 mm
PT317-5919	77005919	FS	48.0 mm	7.0 mm
PT317-1789	284.0402, 971789, 717062	FS	50.0 mm	3.18 mm
MB312-0137	633744-137	FS	50.0 mm	8.0 mm
AM313-0026	71570026	FS	OCTAGONAL	1.5 mm

Centricut is not affiliated with the named manufacturers. Reference to machines, parts, descriptions, and model numbers are for convenience in verifying compatibility only. All parts are made by or for Centricut and are not made by the referenced manufacturers (unless expressly indicated). Centricut is a registered trademark of Hypertherm, Inc. All other trademarks are the properties of their respective owners.

Centricut part number	Reference number	Type	Material	Diameter	Focal length	Edge thickness
CO ₂ lenses						
TR300-0115 NEW (Cut - No RFID)		MEN	ZNSE	1.969"	4.528"	.350"
TR300-0130 NEW (Cut - No RFID)	400130LMA , 0380117, D40 Cut, 630790-117	MEN	ZNSE	1.575"	5.118"	.295"
TR300-8123 NEW	518123	MEN	ZNSE	1.575"	6.102"	.295"
TR300-0175 NEW (Cut - No RFID)	1330448, 62440	MEN	ZNSE	1.969"	6.89"	.350"
TR300-0250 NEW (Cut - No RFID)	400250LMA, 0380115, D40 Cut, 630789-117	MEN	ZNSE	1.575"	9.842"	.295"
TR300-2500 NEW (Cut - No RFID)	1330443, 62439	MEN	ZNSE	1.969"	9.842"	.350"
LL342-1819	166634, 61819	MEN	ZNSE	1.1"	5.0"	.236"
TR300-0163	350163, 861143, LMZ1.5-0.29-10.00-2048	MEN	ZNSE	1.5"	10.0"	.290"
TR300-6477	726477	MEN	ZNSE	1.5"	10.0"	.354"
BY314-0185	4-00185, 4-00372, 142375, 60603	MEN	ZNSE	1.5"	3.75"	.236"
TR300-6104	346104, 61962, 831393	MEN	ZNSE	1.5"	3.75"	.290"
BY314-0736	414323, 4-10736	MEN	ZNSE	1.5"	3.75"	.354"
BY314-0186	60260, 507790, 4-00186, 110111	MEN	ZNSE	1.5"	5.0"	.236"
TR300-8114	088114, 60696, 406294, 110109, 61014, 658108, 29100023, 6930001002	MEN	ZNSE	1.5"	5.0"	.290"
BY314-5094	767963, 60615, 4-05094, 110113, 358186, 62710	MEN	ZNSE	1.5"	5.0"	.354"
PR361-0004	62709, 621644, 120216	MEN	ZNSE	1.5"	5.0"	.354"
PT317-0001	61851, 312370	MEN	ZNSE	1.5"	7.5"	.125"
BY314-0187	784964, 60602, 4-00187, 110112	MEN	ZNSE	1.5"	7.5"	.236"
TR300-7517	097517, 60697, 702232, 110110, 61983	MEN	ZNSE	1.5"	7.5"	.290"
LL342-1171	61171	MEN	ZNSE	1.5"	7.5"	.310"
BY314-5095	60616, 4-05095, 570721, 110114, 361129	MEN	ZNSE	1.5"	7.5"	.354"
BY314-8637	698637	MEN	ZNSE	1.5"	7.5"	.354"
TR300-1972	61961, 141972, 977976	MEN	ZNSE	1.5"	8.85"	.290"
TR300-8123	518123	MEN	ZNSE	1.575"	6.102"	.295"
LV333-0176	480176, 29100115	MEN	ZNSE	1.75"	5.0"	.354"
LV333-1551	981551, LMZ2.0-0.380-10.0-2053, 29100061S	MEN	ZNSE	2.0"	10.0"	.380"
PT317-6326	206326	MEN	ZNSE	2.0"	5.0"	.378"
LV333-1004	458138, LMZ2.0-0.380-5.00-2051, PLLMZ0024, 29100154	MEN	ZNSE	2.0"	5.0"	.380"
CN307-2376	61405, 695399, 922376, 60698, 29100055	MEN	ZNSE	2.0"	7.5"	.380"
AM313-0305	61161, 81140305, LPCZ-1.10-0.16-5.0-1044, PLLPZ0132, 561067	PLX	ZNSE	1.1"	5.0"	.160"
AM313-6602	726602	PLX	ZNSE	1.1"	7.5"	.160"
AM313-0657	600657, 71502030, LPCZ-1.5-0.30-10.0-1128	PLX	ZNSE	1.5"	10.0"	.300"
TK374-2235	312235	PLX	ZNSE	1.5"	12.5"	.300"
PT317-8950	148950	PLX	ZNSE	1.5"	2.5"	.085"
MZ315-0130	60830, Z50MB000130, 962834, 766479	PLX	ZNSE	1.5"	5.0"	.118"
TR300-0002	61163, LMZ1.5-0.16-5.00-2043, 706491, 907557, PLCZ-1.5-0.16-5.0-1116	PLX	ZNSE	1.5"	5.0"	.160"
MZ315-0160	60770, 227092, Z50MB000130H, LPCZ-1.5-0.236-5.0-1122, 834-319-002	PLX	ZNSE	1.5"	5.0"	.236"
PR361-9011	834-319-011, 60905, 658108, ZC15500300, Z50MB000400, 578662, MLL00016	PLX	ZNSE	1.5"	5.0"	.300"
MB312-500	W500, 60905, 110144, LPCZ-1.5-0.30-5.0-1125, PLLPZ0132	PLX	ZNSE	1.5"	5.0"	.310"
CN307-8085	941031, 61001, 908085, ZC15513280, 110092, PLLPZ0033	PLX	ZNSE	1.5"	5.0"WD	.280"
PR361-0003	60784, LPCZ-1.5-0.236-7.5-1123	PLX	ZNSE	1.5"	7.5"	.236"
PR361-9012	834-319-012, 60906, 618938, 306068, 741363, 60882, 299133, 71501070NM, 62649	PLX	ZNSE	1.5"	7.5"	.300"
MB312-018	60906, W018, 383862, 60906LA, W018, 62649ULA, 383862, 62649LA	PLX	ZNSE	1.5"	7.5"	.310"
CN307-9484	909484, 61002, 464497, 100096, LPCZ-1.5-0.280-5.13-1007, PLLPZ0052	PLX	ZNSE	1.5"	7.5"WD	.280"
PT317-8275	628275, W502A, 630736-117	PLX	ZNSE	2.0"	10.0"	.310"
PT317-0537	960537	PLX	ZNSE	2.0"	10.0"	.380"
CN307-4498	154498, 926274	PLX	ZNSE	2.0"	10.0"WD	.380"
TK374-7338	197338	PLX	ZNSE	2.0"	11.25"	.310"
MZ315-5980	145980	PLX	ZNSE	2.0"	5.0"	.300"
MB312-505	W505, 110169, PLLPZ0162, 304725, 61003, Z50ZZ005160	PLX	ZNSE	2.0"	5.0"	.310"
MZ315-0516A	61019, Z50ZZ00516A, Z50ZZ013480, 81140307, 741363	PLX	ZNSE	2.0"	5.0"	.380"

Centricut is not affiliated with the named manufacturers. Reference to machines, parts, descriptions, and model numbers are for convenience in verifying compatibility only. All parts are made by or for Centricut and are not made by the referenced manufacturers (unless expressly indicated). Centricut is a registered trademark of Hypertherm, Inc. All other trademarks are the properties of their respective owners.

Centricut part number	Reference number	Type	Material	Diameter	Focal length	Edge thickness
CO ₂ lenses (continued)						
MZ315-3480HA	158039, Z50ZZ013480 HIGH ACCURACY	PLX	ZNSE	2.0"	5.0"	.380"
CN307-0676	870676, 61514, LPCZ-2.0-0.38-5.19-1141, PLLPZ0116	PLX	ZNSE	2.0"	5.0"WD	.380"
MZ315-3470HA	769062, Z50ZZ013470 HIGH ACCURACY	PLX	ZNSE	2.0"	7.5"	.380"
NT375-4494	634494, LPCZ-2.0-0.30-7.5-1133	PLX	ZNSE	2.0"	7.5"	.300"
MB312-510	W510, 61004, 892020, 110122, PLLPZ0138	PLX	ZNSE	2.0"	7.5"	.310"
MZ315-0520A	61405, 232771, Z50ZZ00520A, MLL00018, Z50ZZ005200, Z50ZZ013470, 81140186	PLX	ZNSE	2.0"	7.5"	.380"
CN307-1603	61515, 781603, LPCZ-2.0-0.38-7.67-1143, PLLPZ0115	PLX	ZNSE	2.0"	7.5" WD	.380"
TK374-3478	541344, 263478, Z50ZZ00530A, LPCZ-2.0-0.31-7.45-1137	PLX	ZNSE	2.0"	8.75"	.310"
TK374-6670	236670, 61690, Z50ZZ00550A	PLX	ZNSE	2.5"	10.0"	.390"
TK374-1592	178937	PLX	ZNSE	2.5"	11.25"	.310"
TK374-8593	828593	PLX	ZNSE	2.5"	12.5"	.390"
TK374-3827	243827, Z50ZZ00540A, LPCZ-2.5-0.31-8.75-1145	PLX	ZNSE	2.5"	8.75"	.310"
AM313-0221	81140221, 6067639	PLX MTD	ZNSE	1.5"	3.75"	.300"
AM313-0306	81140306, 65024, 578662/M16-15-1C-P5.0, PLLPZ0133, 6874793	PLX MTD	ZNSE	1.5"	5.0"	.300"
AM313-1216	578662/M20-15-1C-P5.0, 9001216A, 71501072, 7973109, 6360374	PLX MTD	ZNSE	1.5"	5.0"	.300"
AM313-8662	578662/M21-15-1C-P5.0, 6060415	PLX MTD	ZNSE	1.5"	5.0"	.300"
AM313-9830	65101, 578662, 6547252	PLX MTD	ZNSE	1.5"	5.0"	.300"
AM313-1215	9001215A, 306068/M21-15-1C-P7.5, 7973110, 71501070, 6395647	PLX MTD	ZNSE	1.5"	7.5"	.300"
AM313-9831	71369831, 65102, 6550214	PLX MTD	ZNSE	1.5"	7.5"	.300"
AM313-10F1	680154-001, 71710061, 6021844	PLX MTD	ZNSE	2.0"	10.0"	.380"
AM313-0307	65035, 81140307, 741363, 6068456	PLX MTD	ZNSE	2.0"	5.0"	.380"
AM313-50F1	71710059, 741363M30-20-1C-P5.0, 6296946	PLX MTD	ZNSE	2.0"	5.0"	.380"
AM313-0400	306068, 65025, 81140400, 6022704	PLX MTD	ZNSE	2.0"	7.5"	.300"
AM313-0186	65038, 81140186, PLLPZ0156, 6068413	PLX MTD	ZNSE	2.0"	7.5"	.380"
AM313-75F1	232771M31-20-1C-P7.5, 71710030, 6243925	PLX MTD	ZNSE	2.0"	7.5"	.380"
BY314-7014MP5	460386, 4-07014	MEN	ZNSE MP5	1.5"	10.0"	.354"
BY314-0186MP5	4-00186, 528717, 60260LA	MEN	ZNSE MP5	1.5"	5.0"	.236"
TR300-8114MP5	60696LA, 312503, 29100023, 88114, PLLPZ0125B	MEN	ZNSE MP5	1.5"	5.0"	.290"
BY314-5094MP5	123397, 4-07475, 60615LA, LMZ1.5-0.354-5.0-2008	MEN	ZNSE MP5	1.5"	5.0"	.354"
BY314-0187MP5	714512, 60602LA, 4-00187	MEN	ZNSE MP5	1.5"	7.5"	.236"
TR300-7517MP5	60697LA, 97517, 474644, PLLPZ0126B	MEN	ZNSE MP5	1.5"	7.5"	.290"
BY314-5095MP5	602033, 60616LA, 4-07476, LMZ1.5-0.354-7.5-2009, PLLPZ0130B, 62710	MEN	ZNSE MP5	1.5"	7.5"	.354"
BY314-8294MP5	996707, 10048294	MEN	ZNSE MP5	1.5"	9.0"	.354"
HW405-4913	114913	MEN	ZNSE MP5	2.0"	10.0"	.379"
HW405-5270	355270	MEN	ZNSE MP5	2.0"	5.0"	.378"
HW405-7143	527143, 467572, 60698LA, 291005-5, 308332, PLLMZ0025B	MEN	ZNSE MP5	2.0"	7.5"	.379"
MZ315-0160MP5	60770LA, 857048, Z50MB000160	PLX	ZNSE MP5	1.5"	5.0"	.236"
MZ315-0400MP5	106106, PLLPZ0132B, 60905LA, Z50MB000400, 62670ULA	PLX	ZNSE MP5	1.5"	5.0"	.300"
CN307-8085MP5	61001LA, 794914, 908085,	PLX	ZNSE MP5	1.5"	5.0"WD	.280"
MB312-018MP5	383862	PLX	ZNSE MP5	1.5"	7.5"	.300"
CN307-9484MP5	PLLPZ0052B	PLX	ZNSE MP5	1.5"	7.5"WD	.315"
MB312-505MP5	61003LA, 922203, W505	PLX	ZNSE MP5	2.0"	5.0"	.310"
AM313-0307NMP5	81140307, 61019LA, 753010	PLX	ZNSE MP5	2.0"	5.0"	.380"
CN307-0211MP5	540211, 61019LA, 922377	PLX	ZNSE MP5	2.0"	5.0"WD	.380"
MB312-510MP5	61004LA, 635061, W510,	PLX	ZNSE MP5	2.0"	7.5"	.310"
CN307-2376MP5	329011, 922376, 61515ULA,	PLX	ZNSE MP5	2.0"	7.5"	.380"
MZ315-0520AMP5	392125, 61405LA, Z50ZZ000520A, PLLPZ0135B, 81140186 61405ULA	PLX	ZNSE MP5	2.0"	7.5"	.380"

Centricut is not affiliated with the named manufacturers. Reference to machines, parts, descriptions, and model numbers are for convenience in verifying compatibility only. All parts are made by or for Centricut and are not made by the referenced manufacturers (unless expressly indicated). Centricut is a registered trademark of Hypertherm, Inc. All other trademarks are the properties of their respective owners.

Centricut part number	Reference number	Type	Material	Diameter	Focal length	Edge thickness
CO ₂ lenses (continued)						
AM313-0306MP5	65024LA, 81140306, 106106, M16-15-1C-P5.0, 6936448	PLX MTD	ZNSE MP5	1.5"	5.0"	.300"
AM313-1216MP5	106106, M20-15-1C-P5.0, 6071896	PLX MTD	ZNSE MP5	1.5"	5.0"	.300"
AM313-9830MP5	71369830, 106106, 65101LA, 106106/M16-15-1C-P5.0-A2-NI-1A	PLX MTD	ZNSE MP5	1.5"	5.0"	.300"
AM313-0400MP5	65025LA, 383862/M16-15-1C-P7.5-A2-NI-1A, 81140400, 383862	PLX MTD	ZNSE MP5	1.5"	7.5"	.300"
AM313-1215MP5	M21-15-1C-P7.5, 383862, 6071853	PLX MTD	ZNSE MP5	1.5"	7.5"	.300"
AM313-9831MP5	65102LA, 71369831, 383862	PLX MTD	ZNSE MP5	1.5"	7.5"	.300"
AM313-0307MP5	81140307, M16-20-1C-P5.0, 753010, 65035LA, 753010M16-20-1C-P5.0	PLX MTD	ZNSE MP5	2.0"	5.0"	.380"
AM313-0186MP5	392125, 65038LA, M16-20-1C-P7.5, 81140186, 6816292	PLX MTD	ZNSE MP5	2.0"	7.5"	.380"

Accessories

Centricut part number	Reference number	Description	Pkg qty
TR300-6452		Lens cleaning Tiffen paper (50 pcs)	1
TR300-1115		Lens cleaning pre-cut cotton (100 pcs)	1
TR300-1010		Dropper, lens cleaning fluid	1
TR300-1112		Optical cleaning fluid	1
TR300-0699	70675699 REVA	Lens cleaning swabs (25 pcs)	1
TR300-7991	27991	Polyester wipes 4" x 4" (100 pcs)	1
TR301-0282		Injector	1
TR300-LSA		Lens stress analyzer	1
TR300-255		Magnifying loop	1
TR300-271		Base, mirror maintenance	1
TR300-7388	787388	Mirror polish .1UM 250ML	1
MZ335-115	AL1115/M	MZ-Wire, Indium .8 mm x 125 mm 1.5" Lens	1
MZ335-120	AL1120/M	MZ-Wire, Indium .8 mm x 160 mm 2.0" Lens	1

Centricut is not affiliated with the named manufacturers. Reference to machines, parts, descriptions, and model numbers are for convenience in verifying compatibility only. All parts are made by or for Centricut and are not made by the referenced manufacturers (unless expressly indicated). Centricut is a registered trademark of Hypertherm, Inc. All other trademarks are the properties of their respective owners.

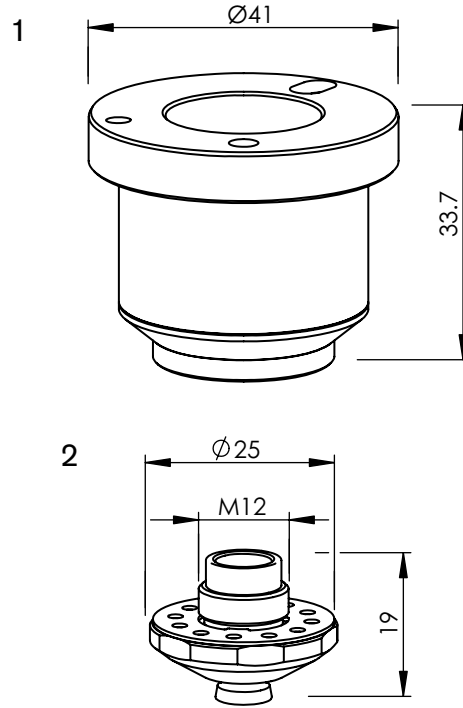

Consumables

	Centricut part number	Esse A part number	Reference number	Description	Pkg qty
1	TR407-6032	AL497	1906032	TR-Nozzle holder, ceramic	1
2	TR407-9940	L1990	1879940	TR-Nozzle EGL, 1.4 mm	1
	TR407-9951	L1991	1879951	TR-Nozzle EGL, 1.7 mm	1
	TR407-9952	L1992	1879952	TR-Nozzle EGL, 2.0 mm	1
	TR407-9953	L1993	1879953	TR-Nozzle EGL, 2.3 mm	1

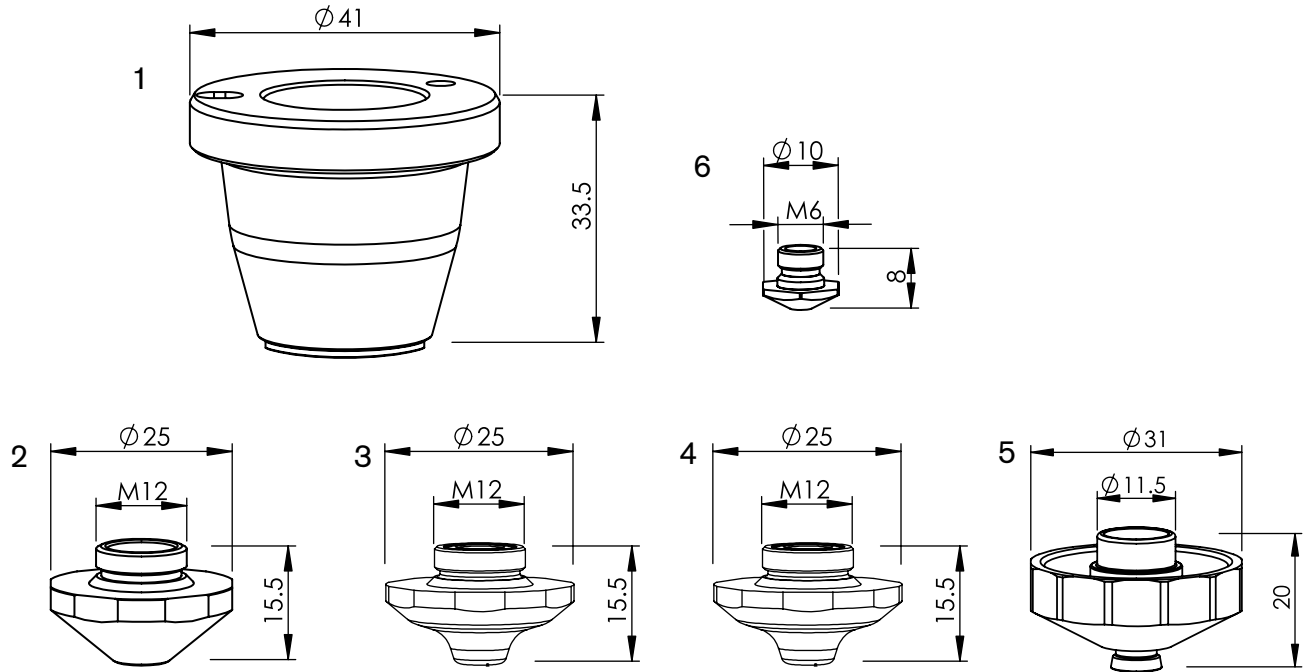

Consumables

	Centricut part number	Esse A part number	Reference number	Description	Pkg qty	
1	TR407-5673	AL410	1349171, 1755673	TR-Nozzle holder, ceramic	1	
2	TR407-4858X	L501270	1324858	TR-Nozzle EAA, 0.8 mm (10 pk)*	10	
	TR407-4860X	L501272	1324860	TR-Nozzle EAA, 1.0 mm (10 pk)*	10	
	TR407-4861X	L501273	1324861	TR-Nozzle EAA, 1.2 mm (10 pk)*	10	
	TR407-4863X	L501275	1324863	TR-Nozzle EAA, 1.4 mm (10 pk)*	10	
	TR407-4864X	L501276	1324864	TR-Nozzle EAA, 1.7 mm (10 pk)*	10	
	TR407-4858CPHX	L501270XH	1324858	TR-Nozzle EAA, 0.8 mm HCP (10 pk)*	10	
	TR407-4860CPHX	L501272XH	1324860	TR-Nozzle EAA, 1.0 mm HCP (10 pk)*	10	
	TR407-4861CPHX	L501273XH	1324861	TR-Nozzle EAA, 1.2 mm HCP (10 pk)*	10	
	TR407-4863CPHX	L501275XH	1324863	TR-Nozzle EAA, 1.4 mm HCP (10 pk)*	10	
	TR407-4864CPHX	L501276XH	1324864	TR-Nozzle EAA, 1.7 mm HCP (10 pk)*	10	
	TR407-4865X	L501277	1324865	TR-Nozzle EAA, 2.0 mm (10 pk)*	10	
	TR407-4866X	L501278	1324866	TR-Nozzle EAA, 2.3 mm (10 pk)*	10	
	TR407-4867X	L501279	1324867	TR-Nozzle EAA, 2.7 mm (10 pk)*	10	
	TR407-4865CPHX	L501277XH	1324865	TR-Nozzle EAA, 2.0 mm HCP (10 pk)*	10	
	TR407-4866CPHX	L501278XH	1324866	TR-Nozzle EAA, 2.3 mm HCP (10 pk)	10	
	TR407-4867CPHX	L501279XH	1324867	TR-Nozzle EAA, 2.7 mm HCP (10 pk)	10	
	3	TR407-9462	L2220	2059462	TR-Nozzle double EAU, 2.5 mm	1
		TR407-0001	L2221	2060001	TR-Nozzle double EAU, 3.0 mm	1
TR407-0004		L2223	2060004	TR-Nozzle double EAU, 4.0 mm	1	
TR407-0025		L2227	2060025	TR-Nozzle double EAU, 6.0 mm	1	
TR407-3595		L2235	2253595	TR-Nozzle double EAU, 10.0 mm	1	
4	TR407-9549	L2240	1579549	TR-Nozzle double EAK, 2.5 mm	1	
	TR407-9556	L2241	1579556	TR-Nozzle double EAK, 3.0 mm	1	
	TR407-5747	L2243	1835747	TR-Nozzle double EAK, 4.0 mm	1	
5	TR407-4018	L1800	1774018	TR-Nozzle EFL, 1.4 mm	1	
	TR407-8745	L1801	1838745	TR-Nozzle EFL, 1.7 mm	1	
	TR407-4020	L1802	1774020	TR-Nozzle EFL, 2.0 mm	1	
	TR407-4092	L1803	1774092	TR-Nozzle EFL, 2.3 mm	1	
6	TR407-9610	L1700	1589610	TR-Nozzle Blow off EBM, 2.0 mm	1	

Centricut is not affiliated with the named manufacturers. Reference to machines, parts, descriptions, and model numbers are for convenience in verifying compatibility only. All parts are made by or for Centricut and are not made by the referenced manufacturers (unless expressly indicated). Centricut is a registered trademark of Hypertherm, Inc. All other trademarks are the properties of their respective owners.

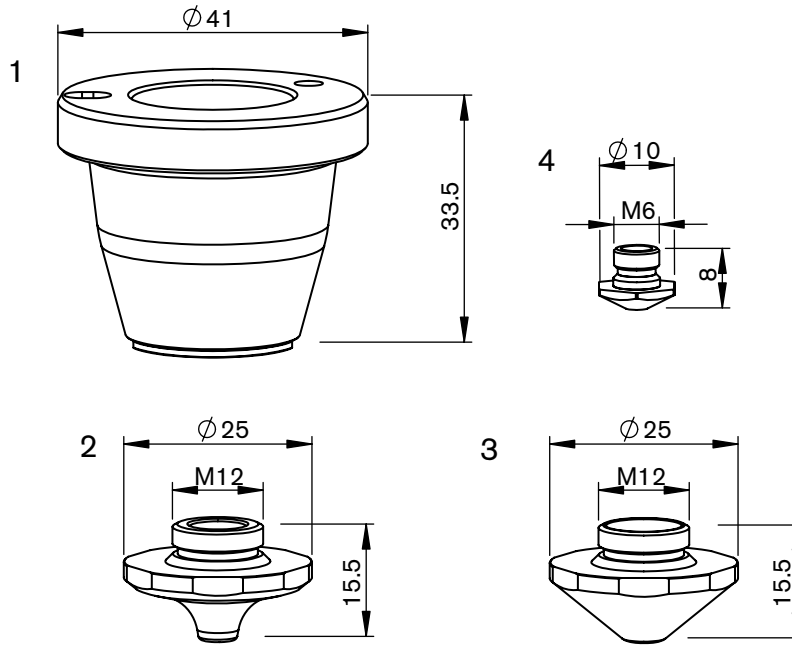

Consumables

	Centricut part number	Esse A part number	Reference number	Description	Pkg qty
1	TR407-5673	AL410	1349171, 1755673	TR-Nozzle holder, ceramic	1
2	TR426-3324X	L501500	1373324	TR-Nozzle EAB, 0.8 mm (10 pk)	10
	TR426-3325X	L501501	1373325	TR-Nozzle EAB, 1.0 mm (10 pk)	10
	TR426-3326X	L501502	1373326	TR-Nozzle EAB, 1.2 mm (10 pk)	10
	TR426-3327X	L501503	1373327	TR-Nozzle EAB, 1.4 mm (10 pk)	10
	TR426-3328X	L501504	1373328	TR-Nozzle EAB, 1.7 mm (10 pk)	10
	TR426-3329X	L501505	1373329	TR-Nozzle EAB, 2.0 mm (10 pk)	10
	TR426-3330X	L501506	1373330	TR-Nozzle EAB, 2.3 mm (10 pk)	10
	TR426-3331X	L501507	1373331	TR-Nozzle EAB, 2.7 mm (10 pk)	10
3	TR426-1308X	L501308		TR-Nozzle double, 0.8 mm (10 pk)	10
	TR426-1309X	L501309		TR-Nozzle double, 1.0 mm (10 pk)	10
	TR426-1310X	L501310		TR-Nozzle double, 1.2 mm (10 pk)*	10
	TR426-1311X	L501311		TR-Nozzle double, 1.4 mm (10 pk)*	10
	TR426-1312X	L501312		TR-Nozzle double, 1.7 mm (10 pk)	10
	TR426-1313X	L501313		TR-Nozzle double, 2.0 mm (10 pk)*	10
	TR426-1314X	L501314		TR-Nozzle double, 2.3 mm (10 pk)	10
	TR426-1315X	L501315		TR-Nozzle double, 2.7 mm (10 pk)	10
4	TR407-9610	L1700	1589610	TR-Nozzle blow off EBM, 2.0 mm	1

* Centricut parts available in single packs. To order single packs, remove the 'X' at the end of the part number (e.g. TR426-1308X would be TR426-1308). For Esse A parts available in single packs. To order single packs, remove the '50' after the L in the part number (e.g. L501308 would be L1308).

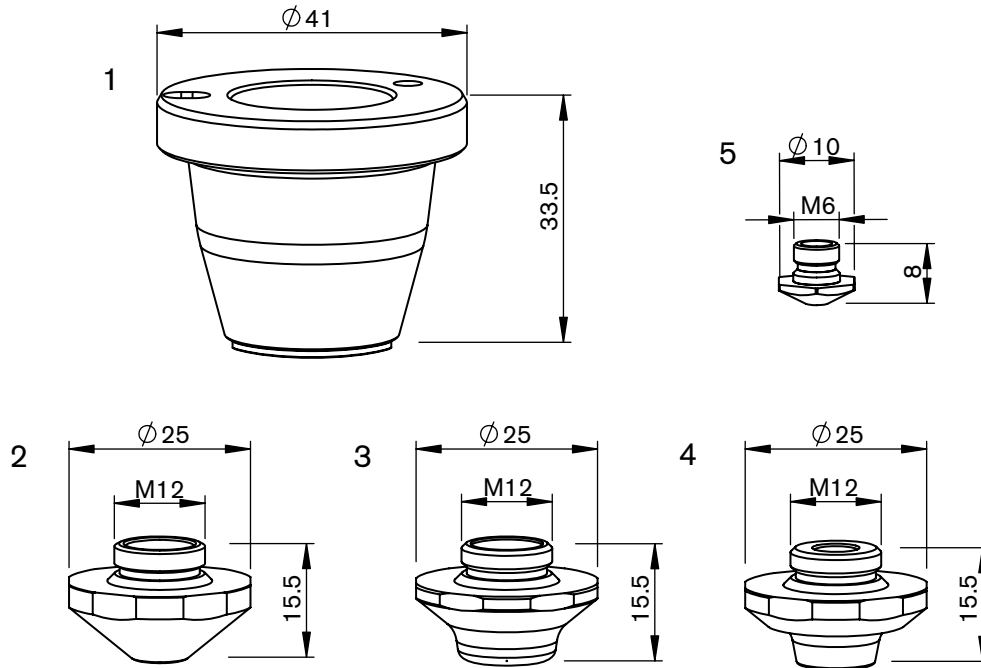

Consumables

	Centricut part number	Esse A part number	Reference number	Description	Pkg qty
1	TR407-5673	AL410	1349171, 1755673	TR-Nozzle holder, ceramic	1
2	TR407-7264	L1260	1637264	TR-Nozzle focusing ZAA-01	1
3	TR407-9091	L1885	1809091	TR-Nozzle double EAQ, 6.0 mm	1
	TR407-9421	L1886	1809421	TR-Nozzle double EAQ, 7.5 mm	1
	TR407-6199	L1887	1886199	TR-Nozzle double EAQ, 9.5 mm	1
4	TR407-3046	L1986	1633046	TR-Nozzle EAC, 5.3 mm	1
5	TR407-9610	L1700	1589610	TR-Nozzle blow off EBM, 2.0 mm	1

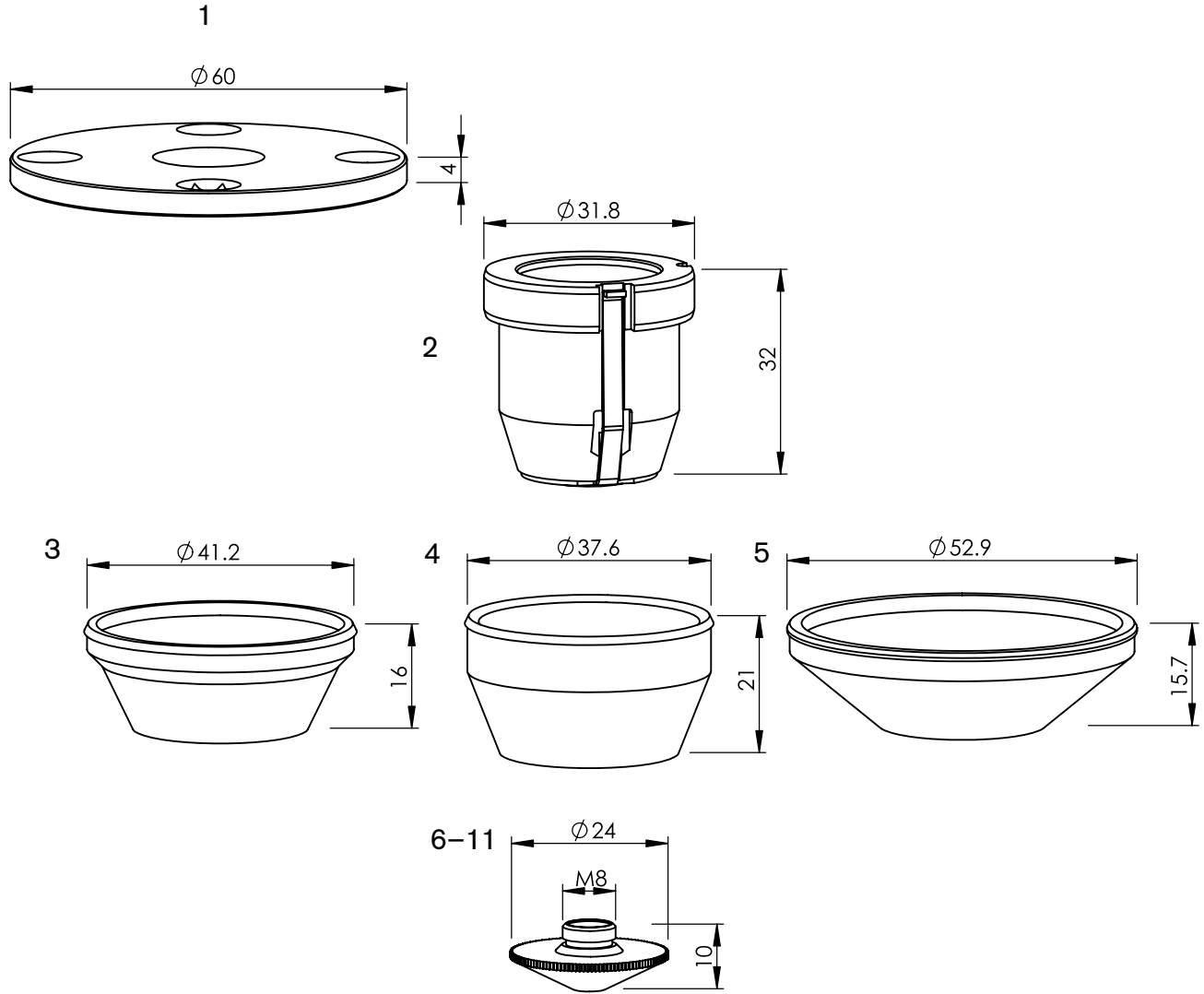

Consumables

	Centricut part number	Esse A part number	Reference number	Description	Pkg qty
1	TR301-4485	AL70	234485	TR-Breakaway plate	1
2	TR301-0432	AL108	254493, 260432	TR-Nozzle holder, ceramic	1
3	TR301-4496	AL36	254496	TR-Cover, PTFE**	1
4	TR301-6153	AL47	256153	TR-Cover, PTFE** (white)	1
	TR301-6153T	AL347	955826	TR-Cover, PTFE** (black)	1
5	TR301-5286	AL41	225286	TR-Cover, PTFE**	1

Centricut is not affiliated with the named manufacturers. Reference to machines, parts, descriptions, and model numbers are for convenience in verifying compatibility only. All parts are made by or for Centricut and are not made by the referenced manufacturers (unless expressly indicated). Centricut is a registered trademark of Hypertherm, Inc. All other trademarks are the properties of their respective owners.

Consumables

	Centricut part number	Esse A part number	Reference number	Description	Pkg qty
6	TR301-4561X	L3018	0124561, 237499	TR-Nozzle, 0.8 mm (10 pk)*	10
	TR301-4562X	L3019	0124562, 237498	TR-Nozzle, 1.0 mm (10 pk)*	10
	TR301-6809X	L30361	0966809	TR-Nozzle, 1.2 mm (10 pk)*	10
	TR301-0014X	L30795		TR-Nozzle, 1.4 mm (10 pk)*	10
	TR301-7500X	L3026	237500	TR-Nozzle, 1.5 mm (10 pk)*	10
	TR301-0017X	L30796		TR-Nozzle, 1.7 mm (10 pk)*	10
	TR301-7503X	L3024	237503, 1253211	TR-Nozzle, 2.0 mm (10 pk)*	10
	TR301-4564X	L30797	124564	TR-Nozzle, 2.3 mm (10 pk)*	10
	TR301-7504X	L3025	237504	TR-Nozzle, 3.0 mm (10 pk)	10
	TR301-0561CPX	L3018X	0352280	TR-Nozzle, 0.8 mm CP (10 pk)*	10
	TR301-0562CPX	L3019X	0352281	TR-Nozzle, 1.0 mm CP (10 pk)*	10
	TR301-0809CPX	L30361X	0352282	TR-Nozzle, 1.2 mm CP (10 pk)*	10
	TR301-0014CPX	L30795X		TR-Nozzle, 1.4 mm CP (10 pk)*	10
	TR301-7500CPX	L3026X	0352288	TR-Nozzle, 1.5 mm CP (10 pk)*	10
	TR301-0017CPX	L30796X		TR-Nozzle, 1.7 mm CP (10 pk)*	10
	TR301-7503CPX	L3024X		TR-Nozzle, 2.0 mm CP (10 pk)*	10
	TR301-4564CPX	L30797X	124564	TR-Nozzle, 2.3 mm CP (10 pk)*	10
	TR301-7504CPX	L3025X	237504	TR-Nozzle, 3.0 mm CP (10 pk)	10
	7	TR301-7497X	L3020	0237497	TR-Nozzle HD, 1.4 mm (10 pk)*
TR301-1497CPX		L3020X	352283	TR-Nozzle HD, 1.4 mm CP (10 pk)*	10
8	TR301-7497-S	L258	237497/S	TR-Nozzle HD, 1.4 mm	1
	TR301-0497X	L30258	237497/S	TR-Nozzle HD, 1.4 mm (10 pk)*	10
	TR301-7501X	L3021	0237501	TR-Nozzle HD, 1.7 mm (10 pk)*	10
	TR301-3211X	L30168	237502, 1253211	TR-Nozzle HD, 2.0 mm (10 pk)*	10
	TR301-6933X	L3076	0126933	TR-Nozzle HD, 2.3 mm (10 pk)*	10
	TR301-0003X	L30185		TR-Nozzle HD, 2.5 mm (10 pk)	10
	TR301-2742X	L30360	0942742	TR-Nozzle HD, 2.7 mm (10 pk)*	10
	TR301-0004X	L30396		TR-Nozzle HD, 3.0 mm (10 pk)	10
	TR301-0497CPX	L30258X		TR-Nozzle HD, 1.4 mm CP (10 pk)*	10
	TR301-0501CPX	L3021X	0352284	TR-Nozzle HD, 1.7 mm CP (10 pk)*	10
	TR301-1002CPX	L30168X	0237502, 352287	TR-Nozzle HD, 2.0 mm CP (10 pk)*	10
	TR301-0933CPX	L3076X	0352285	TR-Nozzle HD, 2.3 mm CP (10 pk)*	10
	TR301-0003CPX	L30185X		TR-Nozzle HD, 2.5 mm CP (10 pk)	10
	TR301-0742CPX	L30360X	0352286	TR-Nozzle HD, 2.7 mm CP (10 pk)*	10
	TR301-1004CPX	L30396X		TR-Nozzle HD, 3.0 mm CP (10 pk)	10
	9	TR301-4561CPX	L3018XH	352280	TR-Nozzle, 0.8 mm HCP (10 pk)*
TR301-4562CPX		L3019XH	352281	TR-Nozzle, 1.0 mm HCP (10 pk)*	10
TR301-6809CPX		L30361XH	352282	TR-Nozzle, 1.2 mm HCP (10 pk)*	10
10	TR301-7497CPX	L3020XH	352283	TR-Nozzle HD, 1.4 mm HCP (10 pk)*	10
11	TR301-0014HCPX	L30258XH		TR-Nozzle HD, 1.4 mm HCP (10 pk)	10
	TR301-7501CPX	L3021XH	352284	TR-Nozzle HD, 1.7 mm HCP (10 pk)*	10
	TR301-0002CPX	L30168XH	237502, 1253212	TR-Nozzle HD, 2.0 mm HCP (10 pk)*	10
	TR301-6933CPX	L3076XH	352285	TR-Nozzle HD, 2.3 mm HCP (10 pk)*	10
	TR301-2742CPX	L30360XH	352286	TR-Nozzle HD, 2.7 mm HCP (10 pk)*	10

* Centricut parts available in single packs. To order single packs, remove the 'X' at the end of the part number (e.g. TR355-0005X would be TR355-0005).

For Esse A parts available in single packs. To order single packs, remove the '30' after the L in the part number (e.g. L30640 would be L640).

** PolyTetraFluoroEthylene is a fluorocarbon-based polymer and is commonly abbreviated PTFE. The Teflon® brand of PTFE is manufactured only by DuPont and is not sold by Hypertherm. Hypertherm purchases other brands of PTFE from various high quality manufacturers.

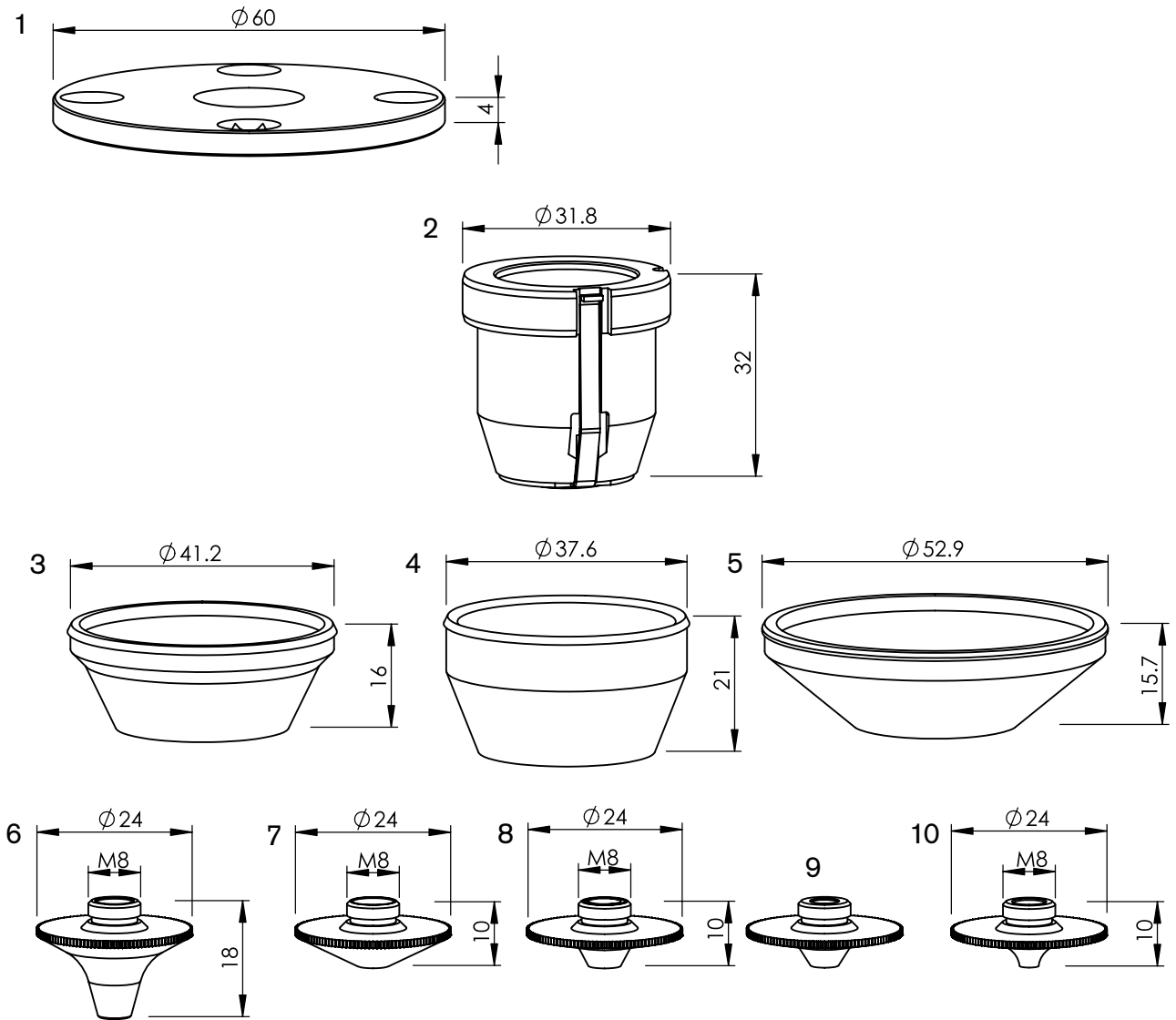

Consumables

	Centricut part number	Esse A part number	Reference number	Description	Pkg qty
1	TR301-4485	AL70	234485	TR-Breakaway plate	1
2	TR301-0432	AL108	254493, 260432	TR-Nozzle holder, ceramic	1
3	TR301-4496	AL36	254496	TR-Cover, PTFE**	1
4	TR301-6153	AL47	256153	TR-Cover, PTFE** (white)	1
	TR301-6153T	AL347	955826	TR-Cover, PTFE** (black)	1
5	TR301-5286	AL41	225286	TR-Cover, PTFE**	1
6	TR301-7773	L1550	1277773	TR-Nozzle, 0.8 mm	1
	TR301-7771	L1551	1277771	TR-Nozzle, 1.0 mm	1
	TR301-7774	L1552	1277774	TR-Nozzle, 1.2 mm	1
	TR301-7776	L1553	1277776	TR-Nozzle, 1.4 mm	1
	TR301-7779	L1554	1277779	TR-Nozzle, 1.7 mm	1
	TR301-7780	L1555	1277780	TR-Nozzle, 2.0 mm	1
	TR301-7781	L1556	1277781	TR-Nozzle, 2.3 mm	1
	TR301-7782	L1557	1277782	TR-Nozzle, 2.7 mm	1

Centricut is not affiliated with the named manufacturers. Reference to machines, parts, descriptions, and model numbers are for convenience in verifying compatibility only. All parts are made by or for Centricut and are not made by the referenced manufacturers (unless expressly indicated). Centricut is a registered trademark of Hypertherm, Inc. All other trademarks are the properties of their respective owners.

Consumables

	Centricut part number	Esse A part number	Reference number	Description	Pkg qty
8	TR355-0001X	L30641		TR-Nozzle double, 1.0 mm (10 pk)	10
	TR355-0006X	L30648		TR-Nozzle double, 1.2 mm (10 pk)*	10
	TR355-0002X	L30642		TR-Nozzle double, 1.4 mm (10 pk)*	10
	TR355-0003X	L30643		TR-Nozzle double, 1.7 mm (10 pk)*	10
	TR355-0007X	L30644		TR-Nozzle double, 2.0 mm (10 pk)*	10
	TR355-0004X	L30645		TR-Nozzle double, 2.3 mm (10 pk)*	10
	TR355-0008X	L30646		TR-Nozzle double, 2.7 mm (10 pk)	10
	TR355-0009X	L30647		TR-Nozzle double, 3.0 mm (10 pk)	10
	TR355-0007CPX	L30644X		TR-Nozzle double, 2.0 mm CP (10 pk)	10
9	TR301-0001X	L30313		TR-Nozzle HD, 2.3 mm (10 pk)*	10
10	TR412-1014CPX	L301034X		TR-Nozzle HD, 1.4 mm CP (10 pk)	10

* Centricut parts available in single packs. To order single packs, remove the 'X' at the end of the part number (e.g. TR355-0005X would be TR355-0005). For Esse A parts available in single packs. To order single packs, remove the '30' after the L in the part number (e.g. L30640 would be L640).

** PolyTetraFluoroEthylene is a fluorocarbon-based polymer and is commonly abbreviated PTFE. The Teflon® brand of PTFE is manufactured only by DuPont and is not sold by Hypertherm. Hypertherm purchases other brands of PTFE from various high quality manufacturers.

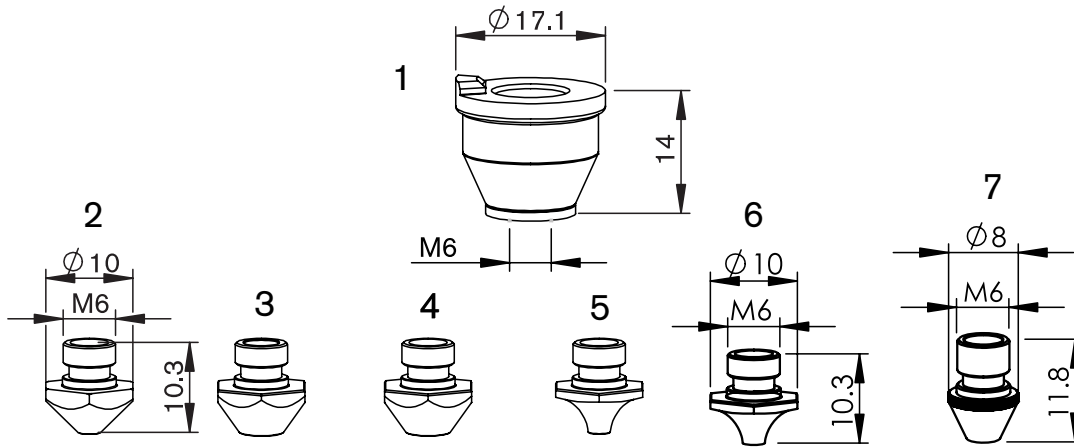

Consumables

	Centricut part number	Esse A part number	Reference number	Description	Pkg qty	
1	TR302-2406 Recommended	AL653	280408, 092405, P0494-752-00001, 6930300016	TR-Nozzle holder KT M1.5" KN	1	
	TR302-2405	AL53	280408, 092405, P0494-752-00001, 6930300016	TR-Nozzle holder KT M1.5" KN OEM	1	
2	TR302-6939X	L40211	226939	TR-Nozzle, 1.0 mm (10 pk)*	10	
	TR302-6940X	L40215	226940	TR-Nozzle HD, 1.4 mm (10 pk)*	10	
	TR302-7144X	L40216	227144	TR-Nozzle HD, 1.7 mm (10 pk)*	10	
3	TR302-7364X		237364	TR-Nozzle shower, 1.0 mm (10 pk)*	10	
4	TR302-4230X	L401150	135420, 1354230	TR-Nozzle EBD, 0.8 mm (10 pk)*	10	
	TR302-2334X	L40255	212334	TR-Nozzle EBD, 1.0 mm (10 pk)*	10	
	TR302-0008CPX	L401150X	135420, 1354230	TR-Nozzle EBD, 0.8 mm CP (10 pk)	10	
	TR302-2334CPX	L40255X	212334	TR-Nozzle EBD, 1.0 mm CP (10 pk)	10	
	TR302-0009X	L401151		TR-Nozzle EBD HD, 0.8 mm (10 pk)	10	
	TR302-0004X	L40270		TR-Nozzle EBD HD, 1.0 mm (10 pk)*	10	
	TR302-6199X	L40256	216199	TR-Nozzle EBD HD, 1.4 mm (10 pk)*	10	
	TR302-5213X	L40257	225213	TR-Nozzle EBD HD, 1.7 mm (10 pk)*	10	
	TR302-7009X	L401147	1487009	TR-Nozzle EBD HD, 2.0 mm (10 pk)*	10	
	TR302-6156X	L40277	126156	TR-Nozzle EBD HD, 2.3 mm (10 pk)*	10	
	TR302-6125X	L401149		TR-Nozzle EBD HD, 2.5 mm (10 pk)	10	
	TR302-0027X	L401152		TR-Nozzle EBD HD, 2.7 mm (10 pk)	10	
	TR302-0009CPX	L401151X		TR-Nozzle EBD HD, 0.8 mm CP (10 pk)	10	
	TR302-0004CPX	L40270X		TR-Nozzle EBD HD, 1.0 mm CP (10 pk)	10	
	TR302-6198X	L401154	1479581	TR-Nozzle EBD HD, 1.2 mm (10 pk)*	10	
	TR302-6199CPX	L40256X	216199	TR-Nozzle EBD HD, 1.4 mm CP (10 pk)	10	
	TR302-5213CPX	L40257X	225213	TR-Nozzle EBD HD, 1.7 mm CP (10 pk)*	10	
	TR302-6156CPX	L40277X	126156	TR-Nozzle EBD HD, 2.3 mm CP (10 pk)	10	
	5	TR302-5320X	L40625		TR-Nozzle, 1.0 mm (10 pk)	10
		TR302-5318X	L40628		TR-Nozzle HD, 1.4 mm (10 pk)*	10
TR302-0017X		L40629		TR-Nozzle HD, 1.7 mm (10 pk)*	10	
6	TR302-5320X	L40267	135320	TR-Nozzle, 1.0 mm (10 pk)	10	
	TR302-0012X	L401153		TR-Nozzle HD, 1.2 mm (10 pk)	10	
	TR302-5318X	L40268	135318	TR-Nozzle HD, 1.4 mm (10 pk)*	10	
	TR302-0017X	L40269	126157	TR-Nozzle HD, 1.7 mm (10 pk)*	10	
7	TR302-1409X	L402122	2241409	TR-Nozzle EBC, 2.0 mm (10 pk)	10	
	TR302-5524X	L402123	2085524	TR-Nozzle EBC, 2.6 mm (10 pk)	10	
	TR302-1406X	L402121	2241406	TR-Nozzle EBC X31, 1.6 mm (10 pk)	10	
	TR302-1407X	L402119	2241407	TR-Nozzle EBC X12, 1.8 mm (10 pk)	10	
	TR302-1524X	L402124	2241524	TR-Nozzle EBC X35, 2.6 mm (10 pk)	10	

* Centricut parts available in single packs. To order single packs, remove the 'X' at the end of the part number (e.g. TR302-4230X would be TR302-4230).
For Esse A parts available in single packs. To order single packs, remove the '40' after the L in the part number (e.g. L401150 would be L1150).

Centricut is not affiliated with the named manufacturers. Reference to machines, parts, descriptions, and model numbers are for convenience in verifying compatibility only. All parts are made by or for Centricut and are not made by the referenced manufacturers (unless expressly indicated). Centricut is a registered trademark of Hypertherm, Inc. All other trademarks are the properties of their respective owners.

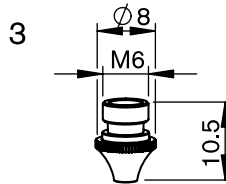
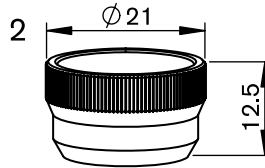
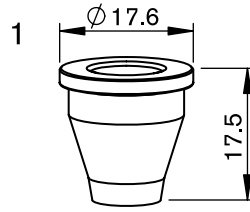

Consumables

	Centricut part number	Esse A part number	Reference number	Description	Pkg qty
	TR302-0354 (not shown)	AL389	960354	TR-Insulating, PTFE**	1
1	TR302-6678 Recommended	AL212	936678, 913966/00-WO, 2509767	TR-Nozzle holder, ceramic	1
	TR302-6678OEM		936678, 913966/00-WO	TR-Nozzle holder, ceramic OEM	1
2	TR352-3965	AL254	913965	TR-Retainer nut	1
3	TR302-8206X	L40745	958206	TR-Nozzle, 0.25 mm (10 pk)*	10
	TR352-3799X	L40500	913799	TR-Nozzle EBG HD, 0.8 mm (10 pk)*	10
	TR352-3800X	L40501	913800	TR-Nozzle EBG HD, 1.0 mm (10 pk)*	10
	TR352-7034X	L40498	1487034	TR-Nozzle EBG HD, 1.2 mm (10 pk)*	10
	TR352-3801X	L40502	913801	TR-Nozzle EBG HD, 1.4 mm (10 pk)*	10
	TR352-7988X	L40503	937988	TR-Nozzle HD, 1.7 mm (10 pk)*	10
	TR352-7991X	L40499		TR-Nozzle HD, 1.75 mm (10 pk)*	10
	TR352-7990X	L40508	1487036	TR-Nozzle HD, 2.0 mm (10 pk)*	10
	TR352-7989X	L40504	937989	TR-Nozzle EBF HD, 2.3 mm (10 pk)*	10
	TR352-3800CPX	L40501X	913800	TR-Nozzle EBG HD, 1.0 mm CP (10 pk)*	10
	TR352-7034CPX	L40498X	1487034	TR-Nozzle EBG HD, 1.2 mm CP (10 pk)*	10
	TR352-3801CPX	L40502X	913801	TR-Nozzle EBG HD, 1.4 mm CP (10 pk)*	10
	TR352-7988CPX	L40503X	937988	TR-Nozzle HD, 1.7 mm CP (10 pk)*	10
	TR352-7990CPX	L40508X		TR-Nozzle HD, 2.0 mm CP (10 pk)*	10
	TR352-7989CPX	L40504X	937989	TR-Nozzle EBF HD, 2.3 mm CP (10 pk)*	10

* Centricut parts available in single packs. To order single packs, remove the 'X' at the end of the part number (e.g. TR302-4230X would be TR302-4230).

For Esse A parts available in single packs. To order single packs, remove the '40' after the L in the part number (e.g. L401150 would be L1150).

** PolyTetraFluoroEthylene is a fluorocarbon-based polymer and is commonly abbreviated PTFE. The Teflon[®] brand of PTFE is manufactured only by DuPont and is not sold by Hypertherm. Hypertherm purchases other brands of PTFE from various high quality manufacturers.

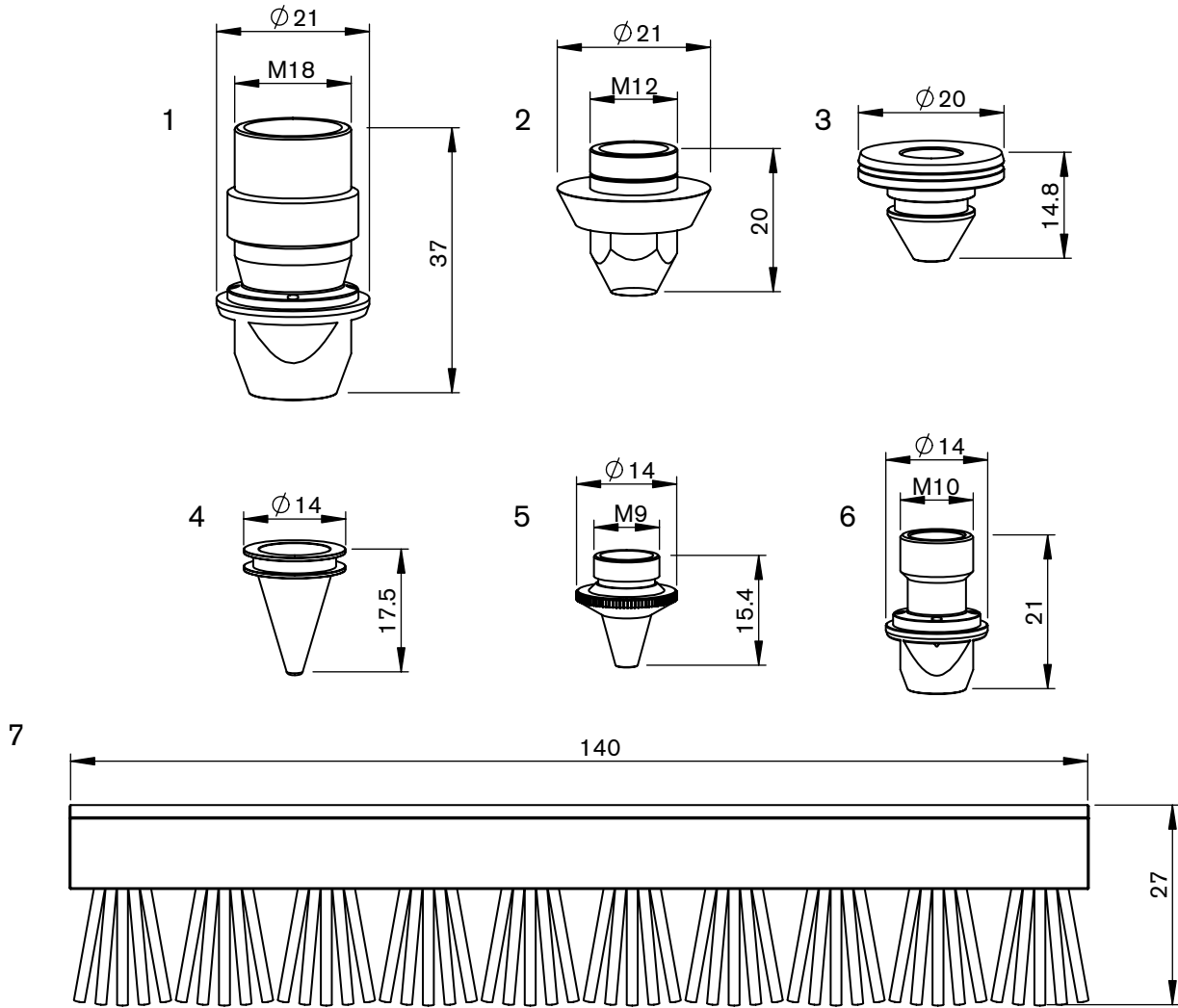

Consumables

	Centricut part number	Esse A part number	Reference number	Description	Pkg qty
1	TR352-0783	L1186	220783	TR-Nozzle welding M18	1
2	TR352-2530CP	L1010X	932530	TR-Nozzle, 4.5 mm CP	1
3	TR303-0969	L34	218969	TR-Nozzle, 1.0 mm	1
4	TR414-0012	L505	12-11-09-17/00	TR-Nozzle YAG w/o-ring, 1.2 mm	1
5	PT344-1813X	L30405	281813, P0589-424-00008	PT-Nozzle, 0.8 mm (10 pk)*	10
	PT344-1789X	L30406	281789, P0589-426-00010	PT-Nozzle, 1.0 mm (10 pk)*	10
	PT344-1561X	L30404	281561, 778550, P0589-425-00012	PT-Nozzle, 1.2 mm (10 pk)*	10
	PT344-1499X	L30407	281814, 149957	PT-Nozzle, 1.5 mm (10 pk)*	10
	PT344-0020X	L30408	P0589-428-00020	PT-Nozzle, 2.0 mm (10 pk)	10
6	TR352-4947	L1185	924947	TR-Nozzle welding M10	1
7	TR301-3202	AL272	0353202, 900594	TR-Brush	1

* Centricut parts available in single packs. To order single packs, remove the 'X' at the end of the part number (e.g. TR355-0005X would be TR355-0005). For Esse A parts available in single packs. To order single packs, remove the '30' after the L in the part number (e.g. L30640 would be L640).

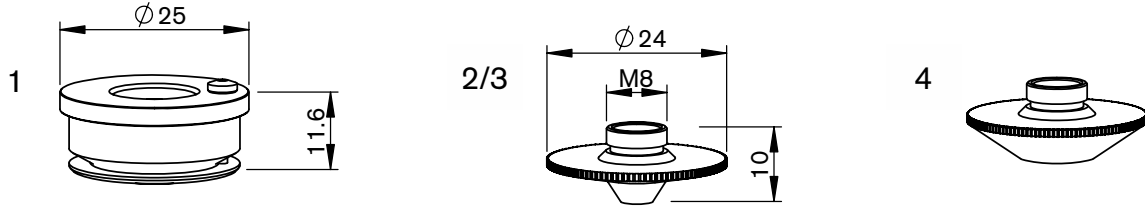

Consumables

	Centricut part number	Esse A part number	Reference number	Description	Pkg qty
1	TR301-8809	AL38	258809, 243839, 247894	TR-Nozzle holder, ceramic	1
	TR301-88090EM	AL400	258809	TR-Nozzle holder, ceramic OEM	1
2	TR301-5780X	L3002	215780	TR-Nozzle, 0.8 mm (10 pack)	10
3	TR301-8894X	L3001	088894	TR-Nozzle HD, 1.4 mm (10 pk)*	10
	TR301-7867X	L3012	217867	TR-Nozzle HD, 1.7 mm (10 pk)*	10
4	TR301-8893X	L3013	088893	TR-Nozzle, 1.5 mm (10 pk)	10
	TR301-1781X	L3068	221781	TR-Nozzle, 2.0 mm (10 pk)	10

* Centricut parts available in single packs. To order single packs, remove the 'X' at the end of the part number (e.g. TR355-0005X would be TR355-0005). For Esse A parts available in single packs. To order single packs, remove the '30' after the L in the part number (e.g. L30640 would be L640).

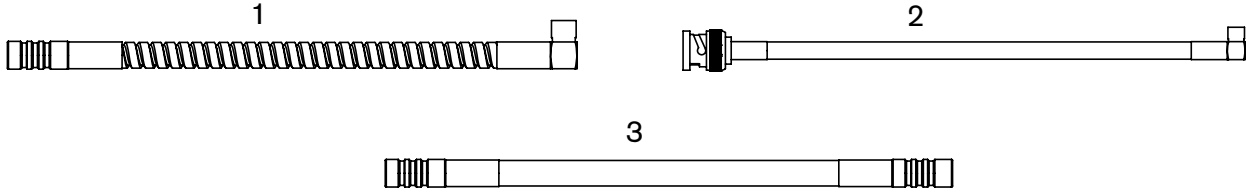

Consumables

	Centricut part number	Esse A part number	Reference number	Description	Pkg qty
1	TR301-9983	AL642	342474, 359983	TR-Sensor cable, 190 mm (7.5") armored	1
2	TR301-7833	AL641	227833	TR-Sensor cable, 432 mm (17")	1
3	TR301-0930	AL640	280930	TR-Sensor cable, 152 mm (6") armored	1

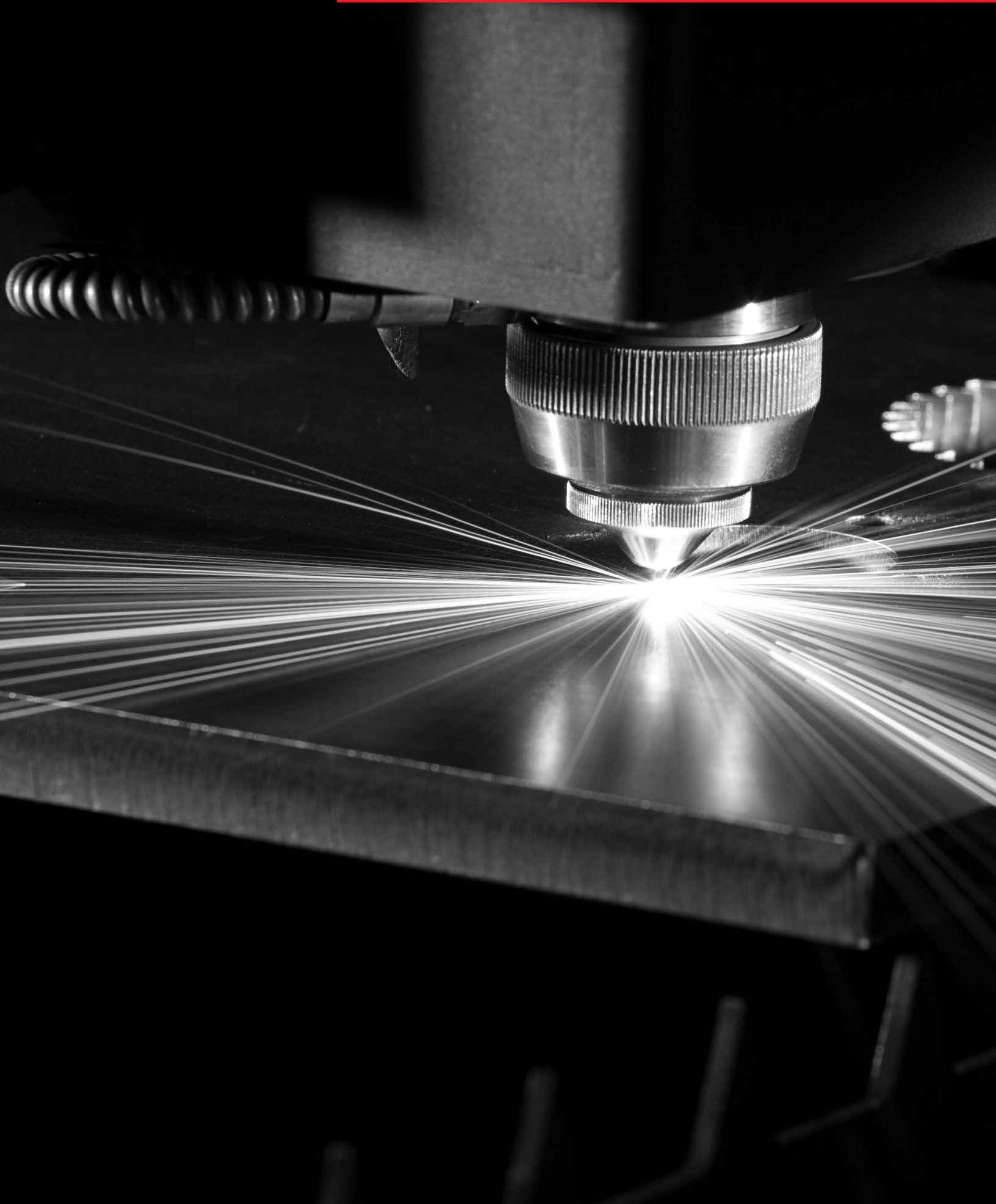

Sensor cones



Centricut sensor cones provide substantial cost savings without sacrificing performance or quality

- Available for Amada, Mazak, Mitsubishi and Precitec
- Delivers the same OEM performance at a lower cost
- Unmatched performance and reliability
- Engineered and manufactured to Hypertherm's precise quality standards
- Backed by our one-year warranty and 100% satisfaction guarantee

Centricut part number	Esse A part number	OEM	Reference number	Description
AM343-0091	AL600	Amada	71360091	AM-Sensor cone, HS95 mini
AM343-1621*	AL601	Amada	71341621	AM-Sensor cone, HS95
AM343-9107	AL603	Amada	ECO cone	AM-Sensor cone, ECO
AM343-1690	AL602	Amada	71341690	AM-Sensor cone, HS98
AM343-L3015C	AL550	Amada	71374509	PT-Sensor cone, LC3015
AM343-2443		Amada	7172443, 771041	AM-Sensor cone, HPL Blue
AM343-4233B*	AL551	Amada	71564233	AM-Sensor cone, HPL Black
AM343-4233G*	AL552	Amada	71564233	AM-Sensor cone, HPL Gold
PT347-3323	AL611	Mazak	HNP	PT-Sensor cone, HNP
MZ335-HNPS*	AL605	Mazak	HNPS	MZ-Sensor cone, HNP short version
PT347-0007		Mazak	56743300500	PT-Sensor cone, HNZ (Mazak)
PT347-0011*	AL607	Mitsubishi	P0354-110-00002	PT-Sensor cone, HNZ (Mitsubishi)
MB334-W429A	AL604	Mitsubishi	P0461-270-00001	MB-Sensor cone, W429A
PT347-0238*	AL608	Precitec	BQ930D238G01	PT-Sensor cone, HNZ SMA
PT347-8001	AL612	Precitec	P0361-203-00001	PT-Sensor cone, 2.5Z/J
PT347-0522*	AL609	Precitec	P0599-520-00002	PT-Sensor cone, LRC
PT347-1145	AL610	Precitec	P0380-140-0002, P0380-130-00001, 281145	PT-Sensor cone, DZ

*Sensor cone repair service is available for most sensor cones in North America and select international regions. For more information contact Ctlaser@Hypertherm.com.

Centricut is not affiliated with the named manufacturers. Reference to machines, parts, descriptions, and model numbers are for convenience in verifying compatibility only. All parts are made by or for Centricut and are not made by the referenced manufacturers (unless expressly indicated). Centricut is a registered trademark of Hypertherm, Inc. All other trademarks are the properties of their respective owners.

Armored sensor cables

Centricut armored sensor cables outlast standard OEM cables

- Available for all major brands
- Robust design with extreme temperature rating (900–1200°)
- Longer life reduces downtime and production loss
- Spatter resistant stainless steel armoring
- Reinforced collars and high-quality connector

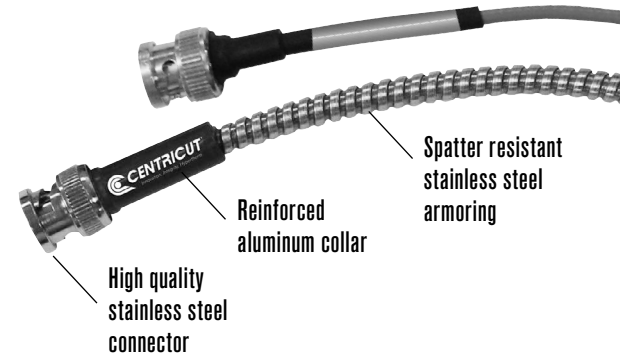

Armored sensor cables

Centricut part number	Esse A part number	OEM	Reference number	Description
AM308-8965	AL260	Amada	71398965	AM-Sensor cable, 305 mm (12")
AM308-8965A	AL613	Amada	71398965	AM-Sensor cable, 305 mm (12") armored
AM313-1901	AL200	Amada	71341630	AM-Sensor cable HS-5, 305 mm (12")
AM313-1901A		Amada	71341630	AM-Sensor cable HS-5, 305 mm (12") armored
AM313-8292	AL615	Amada	71398292	AM-Sensor cable dual shield, 7 m (275.6")
AM313-9851A		Amada	71369851	AM-Sensor cable, 203 mm (8") armored
CN306-0654A	AL616	Cincinnati	909654, 922686	CN-Sensor cable, 114 mm (4.5") armored
CN306-0951A	AL617	Cincinnati	842951	CN-Sensor cable, 140 mm (5.5") armored
CN306-2951	AL618	Cincinnati	842951, PLTTW0015	CN-Sensor cable, 140 mm (5.5")
CN306-9654	AL619	Cincinnati	909654, 922686, PLTTW0002	CN-Sensor cable, 114 mm (4.5")
MZ335-0111A	AL620	Mazak	4674330111	MZ-Sensor cable, 280 mm (11") armored
MZ335-0181A	AL621	Mazak	46743300181	MZ-Sensor cable, 317.5 mm (12.5") armored
MZ335-1330A	AL622	Mazak	46683301330	MZ-Sensor cable, 305 mm (12") armored
MZ335-1980A	AL643	Mazak	46683301980	MZ-Sensor cable, 280 mm (11") armored
MZ335-5320	AL105	Mazak	6143355320	MZ-Sensor cable, 61.5 mm (2.4") armored
MZ335-630A	AL623	Mazak	00BSBA630MNC	MZ-Sensor cable, 630 mm (25") armored
MZ335-8290	AL368	Mazak	46143308290	MZ-Sensor cable, 75 mm (3")
NT426-1682	AL624	NTC	4R029911-001, J482D	NT-Sensor cable, 216 mm (8.5")
NT426-4991	AL625	NTC	3-0104991	NT-Sensor cable 0-OBNC/MCX, 482 mm (19")
NT426-7492	AL626	NTC	3-0117492	NT-Sensor cable 90BNC/90BNC, 482 mm (19")
NT426-8677	AL627	NTC	4R028677-001	NT-Sensor cable, 508 mm (20") armored
PR361-3150	AL628	Prima	820.63.150	PR-Sensor cable, 150 mm (5.9")
PR361-3151	AL629	Prima	820.63.150	PR-Sensor cable, 150 mm (6") high profile
PR361-3160	AL560	Prima	555.63.150	PR-Sensor cable, 210 mm (8 17/64")
PT347-0101A	AL633	Precitec	P0360-100-00500	PT-Sensor cable, 500 mm (20") armored
PT347-0181	AL358	Precitec	46743300181	PT-Sensor cable, 305 mm (12") armored
PT347-0300A	AL635	Precitec	P0492-014-00300	PT-Sensor cable KE, 300 mm (11.8") armored
PT347-0450		Precitec	P0497-002-00450	PT-Sensor cable, 450 mm (17.7")
PT347-KS13	AL639	Precitec/ Gunkyo	00BMTKA-A-HS500mm	PT-Sensor cable, 390 mm (15.5") armored
PT347-1250	AL637	Precitec	D5001-040-00250	PT-Sensor cable, 250 mm (9.8") armored
TR301-0930	AL640	Trumpf	280930	TR-Sensor cable, 152 mm (6") armored
TR301-7833	AL641	Trumpf	227833	TR-Sensor cable, 432 mm (17")
TR301-9983	AL642	Trumpf	359983, 342474	TR-Sensor cable, 190 mm (7.5") armored

Centricut is not affiliated with the named manufacturers. Reference to machines, parts, descriptions, and model numbers are for convenience in verifying compatibility only. All parts are made by or for Centricut and are not made by the referenced manufacturers (unless expressly indicated). Centricut is a registered trademark of Hypertherm, Inc. All other trademarks are the properties of their respective owners.

Lens cleaning tips



Centricut supplies suitable for all OEM CO₂ and fiber laser lenses

- Lens maintenance base is designed to secure a wide range of optics sizes for the cleaning process
- Centricut optical cleaning fluid is a safe, economical alternative to traditional high-purity and reagent-grade solvents
- Cleaning materials suited for all lens cleaning needs; lens paper, polyester swabs and polyester wipes

Lens paper

Recommended for the routine maintenance cleaning of flat lenses.

Polyester swabs

Recommended for cleaning curved lenses and where a more aggressive cleaning is required (interchangeable with polyester wipes).

Polyester wipes

Recommended for cleaning CO₂ and fiber lenses and windows (interchangeable with polyester swabs and lens paper).

Product description	Part number	Quantity per order
Optical cleaning fluid (3 oz.)	TR300-1112	1
Lens cleaning swab	TR300-0699	25
Lens cleaning paper, Tiffen	TR300-6452	50
Polyester wipes 4" x 4"	TR300-7991	100
Base, lens maintenance	TR300-271	1

Lens paper

Recommended for the routine maintenance cleaning of flat lenses.

You will need:

- Lens maintenance base (lens holder)
- Optical cleaning fluid
- Air bulb
- Lint-free lens paper
- Latex or rubber gloves



To get started

Using rubber gloves, place the lens in the lens holder and remove all loose contaminants with an air bulb. When contaminants are no longer visible, begin the cleaning process.

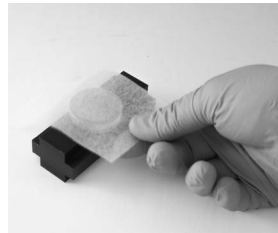

Step 1

Place lens paper over the optic, covering it completely.



Step 2

Apply a couple drops of lens cleaning fluid to the lens paper (far side of the lens).

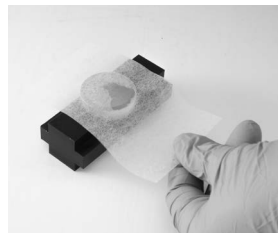

Step 3

Slowly pull the lens paper across the lens so the cleaning fluid comes in contact with the entire lens surface. Finish pulling the paper across so all of the fluid has dried from the lens.

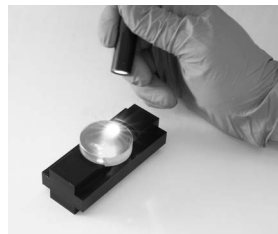

Step 4

Inspect the surface of the lens for dust and cleaning residue using a flashlight. Examine the lens from different angles. Repeat the process on the other side of the lens.

Final step:

Place the cleaned lens in the machine quickly to avoid contamination from airborne particles. If spots, pits, or scratches are still noticeable, the lens may need to be replaced.

Centricut is not affiliated with the named manufacturers. Reference to machines, parts, descriptions, and model numbers are for convenience in verifying compatibility only. All parts are made by or for Centricut and are not made by the referenced manufacturers (unless expressly indicated). Centricut is a registered trademark of Hypertherm, Inc. All other trademarks are the properties of their respective owners.

Polyester swabs

Recommended for cleaning curved lenses and where more aggressive cleaning is required. Interchangeable with polyester wipes.

You will need:

- Lens maintenance base (lens holder)
- Optical cleaning fluid
- Air bulb
- Polyester swabs
- Latex or rubber gloves

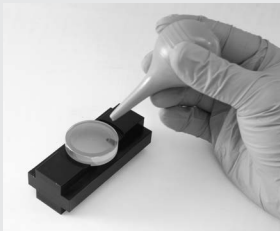

To get started

Using rubber gloves, place the lens in the lens holder and remove all loose contaminants with an air bulb. When contaminants are no longer visible, begin the cleaning process.



Step 1

Place a few drops of the optical cleaning fluid onto the swab.

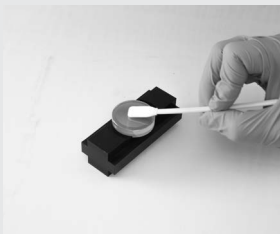

Step 2

Move the larger dirt particles and then finer contaminants to the edge of the lens using the swab. Do not rest the swab on the lens or on the work table. Do not reuse swabs.

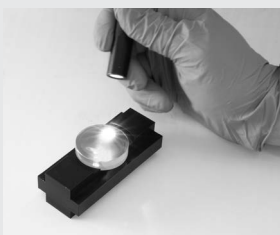

Step 3

Inspect the surface of the lens for dust and cleaning residue using a flashlight. Examine the lens from different angles. Repeat the process on the other side of the lens.

Final step:

Place the cleaned lens in the machine quickly to avoid contamination from airborne particles. If spots, pits, or scratches are still noticeable, the lens may need to be replaced.

Polyester wipes

Recommended for cleaning CO₂ and fiber lenses and windows. Interchangeable with polyester swabs and lens paper.

You will need:

- Lens maintenance base (lens holder)
- Optical cleaning fluid
- Air bulb
- Polyester wipes
- Latex or rubber gloves



To get started

Using rubber gloves, place the lens in the lens holder and remove all loose contaminants with an air bulb. When contaminants are no longer visible, begin the cleaning process.



Step 1

Place a few drops of the optical cleaning fluid onto the polyester wipe.



Step 2

Place the wipe with the wet side down on the lens and slide it across the lens, applying light pressure to the top of the wipe. Avoid contamination to the wipe and do not reuse wipes.

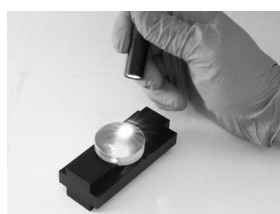

Step 3

Inspect the surface of the lens for dust and cleaning residue using a flashlight. Examine the lens from different angles. Repeat the process on the other side of the lens.

Final step:

Place the cleaned lens in the machine quickly to avoid contamination from airborne particles. If spots, pits, or scratches are still noticeable, the lens may need to be replaced.

Steps to help optimize cut quality.

Striation marks, angularity and dross tell the story.

Optimizing CO₂ and fiber lasers to achieve maximum cut quality is a very important step in the overall cutting process. The critical points that produce good cuts are the width of the kerf (the material that is lost during the cut), oxidation and roughness of the cut surface, the geometry of the cut parts and the allowable tolerances. Some factors to be considered are the cut speed or 'feed rate', beam focus, gas pressure, standoff and nozzle size/type.

Factory cut chart settings

The following samples show 12 mm, 6 mm and 3.2 mm (1/2", 1/4" and 10 ga.) mild steel, cut with O₂ on a 2 kW fiber laser with one variable changed to show how cut quality is affected. The adjustments will be similar for all CO₂ and fiber laser, cutting mild steel with O₂.

Is the kerf too narrow?

When the kerf is too narrow the cut will have a very smooth edge on the top, a lack of oxidation on the bottom and/or heavy dross.

Probable causes:

- Focus is too low
- Feed rate is too fast
- Gas pressure is too low
- Nozzle size is too small
- Standoff is too low

Follow these steps to optimize cut quality:

1. Use the closest known settings for the material being cut.
2. Use a test part that has both interior and exterior features.
3. Verify that the lens and/or window is clean and in good condition.
4. Verify that the nozzle is centered properly and is in good condition.
5. Adjust the focus up and down until the cut quality starts to get bad and then set to the middle of that range.
6. Adjust the gas pressure up and down until the cut starts to get bad and then set to the middle of that range.
7. Adjust the feed rate up by 5% increments. When the cut starts to get bad, set the feed rate 10% slower.

Strike a balance between heat levels and gas flow

Cutting mild steel with a laser is a balance of how much material is heated by the laser beam and how much assist gas flows through the cut.

- Heating up too small of an area, or not having enough assist gas flow through the cut will result with the kerf (width of the cut) being too narrow.
- Heating up too large of an area or having too much assist gas flow through the cut will result in the kerf being too wide.

Is the kerf too wide?

When the kerf is too wide the cut will have a rougher edge, more self burning in the corners of the part, more angularity on the cut edge and occasionally, dross.

Probable causes:

- Focus is too high
- Feed rate is too slow
- Gas pressure is too high
- Nozzle size is too big
- Standoff is too high
- Incorrect nozzle type

3.2 mm (10 ga.) mild steel cut resulting in too narrow kerf

Factory cut chart settings

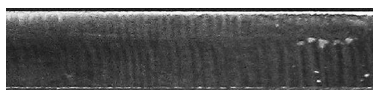

Focus is too low

The kerf is too narrow and doesn't allow enough O₂ into the cut to remove all the molten material.

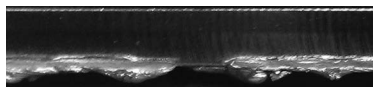

Feed rate is too fast

The cut striations are trailing the direction of cutting and there is not enough time to remove all the molten material.

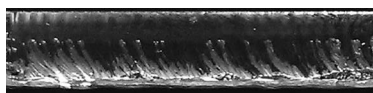

Gas pressure is too low

There is not enough O₂ to remove all the molten material.

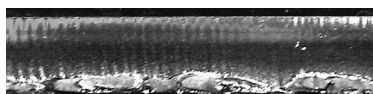

Stand off is too low

The focus spot is in the wrong location, causing the rough edge.

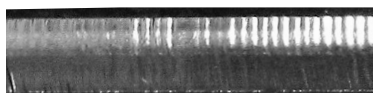

3.2 mm (10 ga.) mild steel cut resulting in too wide kerf

Factory cut chart settings



Focus is too high

The laser is melting more material than can be removed from the cut.

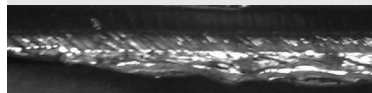

Feed rate is too slow

The cut surface is too rough and productivity is decreased.

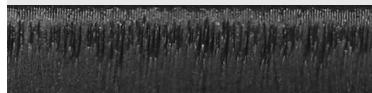

Gas pressure is too high

Too much O₂ results in overheating of the cut and causes intermittent gouges.

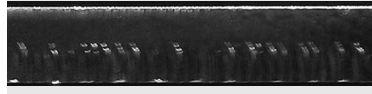

Stand off is too high

The laser is melting more material than can be removed from the cut.

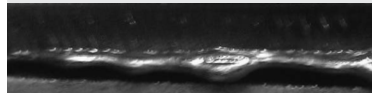

Nozzle size is too big

Too much O₂ results in overheating of the cut and causes intermittent gouges.



*Above samples have been cut with O₂ on 2 kW fiber laser. Results will be similar for CO₂ laser cutting mild steel with O₂.

6 mm (1/4") mild steel cut resulting in too narrow kerf

Factory cut chart settings

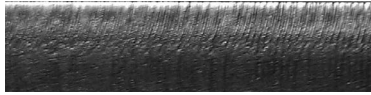

Focus is too low

The kerf is too narrow and doesn't allow enough O₂ into the cut to remove all the molten material.

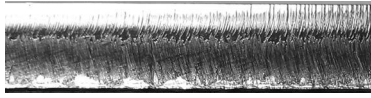

Feed rate is too fast

The cut striations are trailing the direction of cutting and there is not enough time to remove all the molten material.

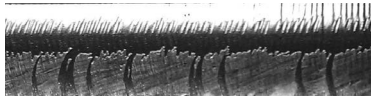

Gas pressure is too low

There is not enough O₂ to remove all the molten material.

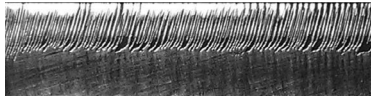

Stand off is too low

The focus spot is in the wrong location, causing the rough edge.

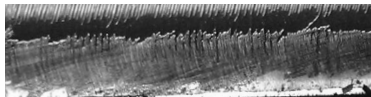

Nozzle size is too small

There is not enough O₂ to cut uniformly.

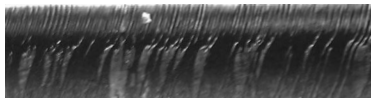

6 mm (1/4") mild steel cut resulting in too wide kerf

Factory cut chart settings

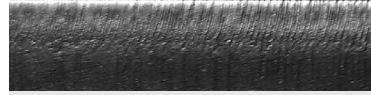

Focus is too high

The wider focus spot is letting too much O₂ into the cut and burning the material.

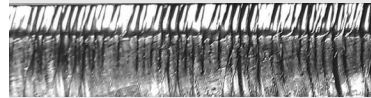

Feed rate is too slow

The cut surface is too rough and productivity is decreased.

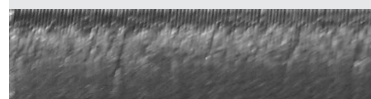

Gas pressure is too high

Too much O₂ is entering the cut, causing a rougher edge and inconsistent cutting.

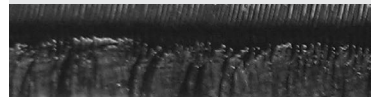

Stand off is too high

Too much O₂ is entering the cut, causing a rougher edge and inconsistent cutting.

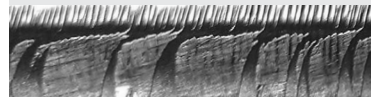

Nozzle size is too big

Too much O₂ results in overheating of the cut and causes intermittent gouges.



Nozzle type is incorrect

The shape of the gas flow is incorrect, causing a rougher edge.

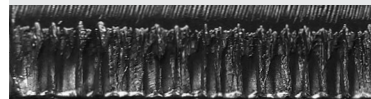

Cut direction

Cut direction

*Above samples have been cut with O₂ on 2 kW fiber laser. Results will be similar for CO₂ laser cutting mild steel with O₂.

Centricut is not affiliated with the named manufacturers. Reference to machines, parts, descriptions, and model numbers are for convenience in verifying compatibility only. All parts are made by or for Centricut and are not made by the referenced manufacturers (unless expressly indicated). Centricut is a registered trademark of Hypertherm, Inc. All other trademarks are the properties of their respective owners.

12 mm (1/2") mild steel cut resulting in too narrow kerf

Factory cut chart settings

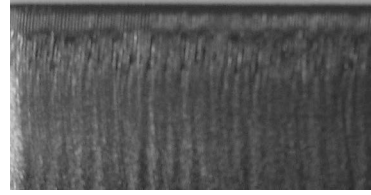
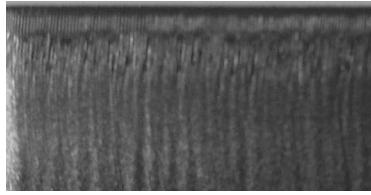

Factory cut chart settings

Focus is too low

The kerf is too narrow and doesn't allow enough O₂ into the cut to remove all the molten material.

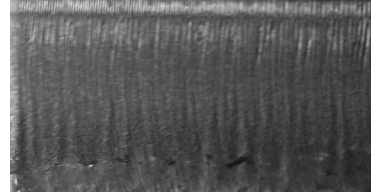
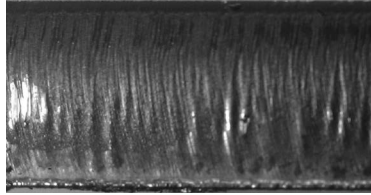

Stand off is too low

The kerf is too narrow to allow enough O₂ into the cut. The oxidation is not covering the entire surface and cutting will be inconsistent.

Feed rate is too fast

The machine is moving too fast to allow enough O₂ into the cut for consistent cutting.

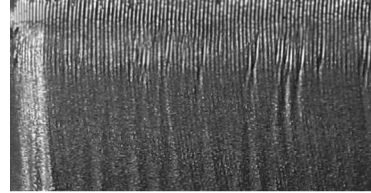
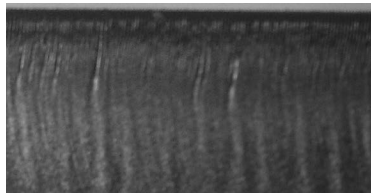

Nozzle size is too small

There is not enough O₂ to cut uniformly.

Gas pressure is too low

The pressure is too low to allow enough O₂ into the cut. The oxidation is not covering the entire surface and cutting will be inconsistent.

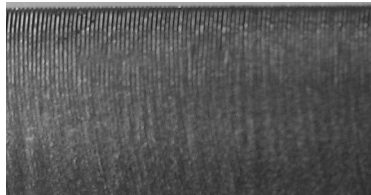

Cut direction

Cut direction

*Above samples have been cut with O₂ on 2 kW fiber laser. Results will be similar for CO₂ laser cutting mild steel with O₂.

Centricut is not affiliated with the named manufacturers. Reference to machines, parts, descriptions, and model numbers are for convenience in verifying compatibility only. All parts are made by or for Centricut and are not made by the referenced manufacturers (unless expressly indicated). Centricut is a registered trademark of Hypertherm, Inc. All other trademarks are the properties of their respective owners.

12 mm (1/2") mild steel cut resulting in too wide kerf

Factory cut chart settings

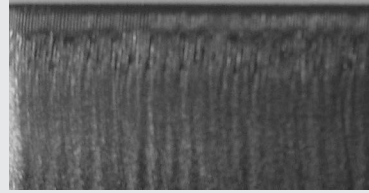
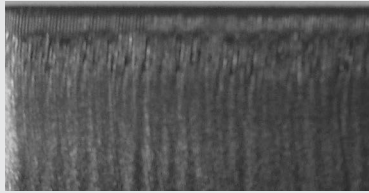

Factory cut chart settings

Focus is too high

Too much O₂ is entering the cut causing intermittent over burning.

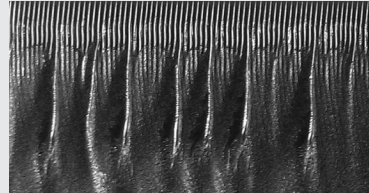
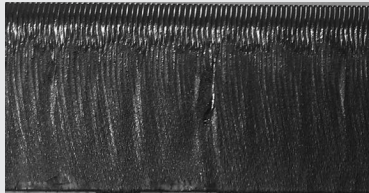

Stand off is too high

Too much O₂ is entering the cut resulting in intermittent over burning.

Feed rate is too slow

The machine is moving too slow resulting in the over burning of the bottom half of the cut. The slower feed rate also reduces productivity.

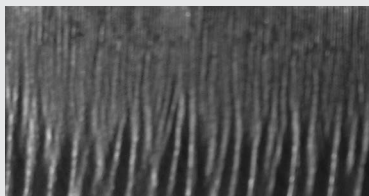

Incorrect nozzle type

The gas flow shape is not correct resulting in inconsistent cutting.

Gas pressure is too high

Too much O₂ is entering the cut resulting in intermittent over burning.

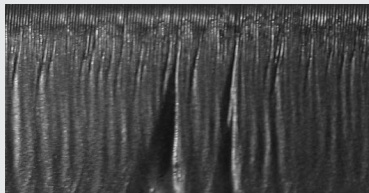

*Above samples have been cut with O₂ on 2 kW fiber laser. Results will be similar for CO₂ laser cutting mild steel with O₂.

Centricut is not affiliated with the named manufacturers. Reference to machines, parts, descriptions, and model numbers are for convenience in verifying compatibility only. All parts are made by or for Centricut and are not made by the referenced manufacturers (unless expressly indicated). Centricut is a registered trademark of Hypertherm, Inc. All other trademarks are the properties of their respective owners.

Technical support and customer service

Our technical service team can answer questions about any laser cutting system. Whether it's a question about a part, a system or for guidance on how to optimize laser cutting performance, our experts can help.

- OEM trained technicians with over 40 years experience
- Free application support for all laser OEMs
- We stand behind our products with industry-leading technical expertise



Contact a laser expert at ctlaser@hypertherm.com

SHAPING POSSIBILITY[®]

PLASMA | LASER | WATERJET | AUTOMATION | SOFTWARE | CONSUMABLES

For more information on Centricut laser products,
visit www.hypertherm.com/laserconsumables
or email ctlaser@hypertherm.com

Hypertherm, Centricut, SilverLine and CoolFlow are trademarks of Hypertherm, Inc., and may be registered in the United States and/or other countries. All other trademarks are the property of their respective owners.

Please visit www.hypertherm.com/patents for more details about Hypertherm Associates patent numbers and types.

© 3/2023 Hypertherm, Inc. Revision 11



As 100% Associate owners, we are all focused on delivering a superior customer experience.
www.hyperthermassociates.com/ownership

Environmental stewardship is one of Hypertherm Associates' core values. www.hyperthermassociates.com/environment

100% Associate-owned

